



SINCE 1909
JAPAN

通風系統

AIR MOVING EQUIPMENT



生活充滿新氣
Providing you with a
breath of Fresh Air



目錄 Content

3 窗口式抽氣扇 Window Mount Type

6 掛牆式抽氣扇 Wall Mount Type

9 浴室用抽氣扇 Bathroom Type

10 浴室換氣暖風機 Thermo Ventilator

15 天花板式抽氣扇 Ceiling Mount Type

22 抽油煙機 Range Hood

22 風閘 Air Curtain

23 乾手機 Eco-Dry (Hand Dryer)

24 規格 Specifications

特點 FEATURES HIGHLIGHT

1 全新HP馬達及軸承 New HP Motor & Bearing

(15AAQT07 / 15WHB07 / 20WHB07 / 15WJA07 / 10BAQT07 除外)

比較舊型號，新型號採用高性能電容馬達及長壽命軸承，使產品更耐用持久。以掛牆式抽氣扇為例，平均使用時間由30,000小時增至60,000小時。並且，能源消耗平均節省達13%。 Compared with previous models, new models adopt high performance condenser motor and long life bearing that prolong the product durability. As for example of wall mount ventilating fan, from average 30,000 hours life time to 60,000 hours. They also enable energy saving by reducing power consumption down to average 13%.

軸承 Bearing

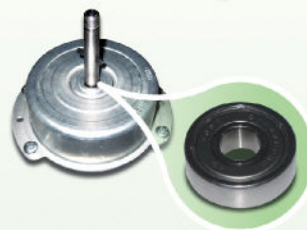

新型號採用HP馬達及軸承
"HP motor" and "Bearing" used in new models

軸套 Sintered Bush



舊型號
Previous models



低耗電量 Low Power Consumption

	型號 Model No.	電量 Power Consumption (W)	
窗口式抽氣扇 Window Mount Type	15WUC	14	節省多達43% 43% down
	15WUE*	8	
掛牆式抽氣扇 Wall Mount Type	20DLB	27	節省多達19% 19% down
	20DLC*	22	

* 新型號 New Model



持久耐用 Long Life

	HP 馬達 HP Motor	舊型號 Previous Motor
軸承種類 Bearing Type	軸承 Bearing	軸套 Bush
慳電量 Power Consumption Saving	👍👍👍	👍
耐用 Long Life	👍👍👍	👍

- 窗口式抽氣扇：較舊型號耐用平均1.5倍
Window Mount Type: On average 1.5 times vs previous model
- 掛牆式抽氣扇：較舊型號耐用平均2倍
Wall Mount Type: On average 2 times vs previous model

2 斬新扇葉設計 Advanced Blade Design

(30ALF07 / 15AAQ107 / 10BAQ107除外)

不論是窗口式或是掛牆式，均採用斬新扇葉設計 - 利用空氣動力原理，減少對氣流的任何阻力。

For both window mount and wall mount type, new blade design are applied. It uses advanced aerodynamic principle to minimize any obstacles against the airflow.

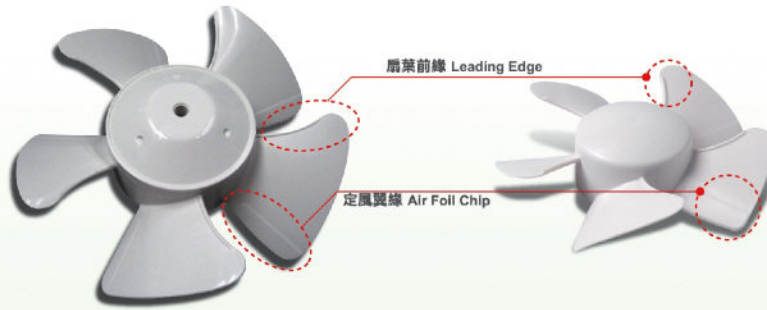

定風翼緣能減低扇葉後邊的亂流，其前方的弧度經改良後，有助氣流流動，並有效減少噪音。Air Foil Chip is to reduce turbulence at rear edge, and curvature of front edge is improved for smooth airflow that minimizes fan noise as well.

經改良的扇葉前緣不會對氣流形成障礙，任何角度空氣都能順利流通
Leading Edge forms no obstacle to airflow that streamlines airflow from every direction



強化開關窗結構 Strengthened Shutter Structure*

- 耐用 Durable
- 有效抵禦強風 Sustainable to strong wind



金屬製開關窗軸心，產品更堅固耐用。
Metallic Shutter axis is used as the supporter for movement of shutter that provides a better endurance.

* WUL / WU 系列適用

窗口式抽氣扇 Window Mount Type

圓形安裝孔 Circle Installation Hole

標準型 Standard Type 15WUE07 (6") 20WUE07 (8")

單位 unit : 毫米 mm

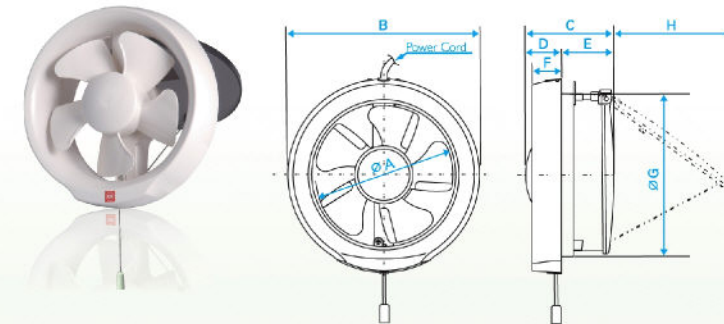

MODEL NO.		A	B	C	D	E	F	G	H	Installation Size
15WUE07	mm	150	210	97	43	54	38	177	149	ø 186-188
	inch	5.91	8.27	3.82	1.69	2.13	1.5	6.97	5.87	ø 7.32-7.40
20WUE07	mm	200	271	96	36	62	36	237	201	ø 247-250
	inch	7.88	10.67	3.86	1.42	2.44	1.42	9.33	7.92	ø 9.73-9.85

網罩型 Louver Type 15WULA07 (6") 20WULA07 (8")

單位 unit : 毫米 mm

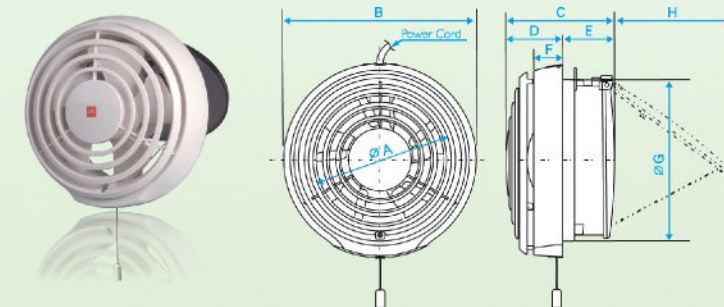

MODEL NO.		A	B	C	D	E	F	G	H	Installation Size
15WULA07	mm	150	210	119	65	54	38	177	149	ø 186-188
	inch	5.91	8.27	4.69	2.56	2.13	1.5	6.97	5.87	ø 7.32-7.40
20WULA07	mm	200	271	127	65	62	36	237	201	ø 247-250
	inch	7.88	10.67	5.00	2.56	2.44	1.42	9.33	7.92	ø 9.73-9.85

(只需一人)可在室內完成所有安裝和拆卸工序，省時方便。

Only one person can install and remove the fan inside the rooms for easy installation and cleaning.

型號 Model	15WUE07 / 15WULA07	20WUE07 / 20WULA07
安裝孔直徑 Diameter of Installation Hole	186-188mm	247-250mm
建議安裝玻璃厚度 Recommended Glass Thickness	3-7mm	3-7 mm



電動百葉背板開關設計
Electrically Operated Shutter

- 弧形雙百葉設計，遮風擋雨
Dome shaped hood with 2-piece shutter design. Rain proof and wind resistible
- 強力通風及在高靜壓下運作
Powerful airflow and sustainable to high static pressure (Hi 90 / Lo 51 Pa)
- 前置安全網，安全美觀
Attached front louver for safety and better outlook
- 附設上/左/右電線出口位，使安裝靈活度更高。
3-way (upside/left/right) power cord opening for more flexibility
- 時尚設計
Modern design
- 兩種風速選擇
2-speed selectable
- 安裝簡便
Easy installation
- 方便清洗
Easy clean
- 適合一般浴室使用
Suitable for bathroom
- 符合防水安全規格IPX4 (室外)
Comply with IPX4 (Outside)

15WJA07 (6")

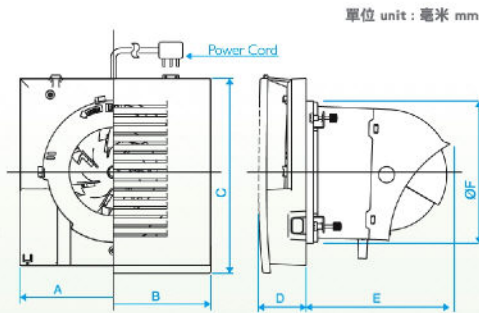

MODEL NO.		A	B	C	D	E	F	Installation Size
15WJA07	mm	244	254	254	65	168	165.1	φ 186-190
	inch	9.6	10	10	2.6	7.4	7.3	φ 7.32-7.48



(只需一人)可在室內完成所有安裝和拆卸工序，省時方便。
Only one person can install and remove the fan inside the rooms for easy installation and cleaning.

型號 Model	15WJA07
安裝孔直徑 Diameter of Installation Hole	186-190mm
建議安裝玻璃厚度 Recommended Glass Thickness	5-9mm

15WHB07 (6")



20WHB07 (8")



電動百葉背板開關設計
Electrically Operated Shutter

- 前置安全網，安全美觀
Attached front louver for safety and better outlook
- 安裝簡便，方便清洗
Easy installation and easy clean
- 適合一般浴室使用
Suitable for bathroom
- 符合防水安全規格IPX4 (室外)
Comply with IPX4 (Outside)

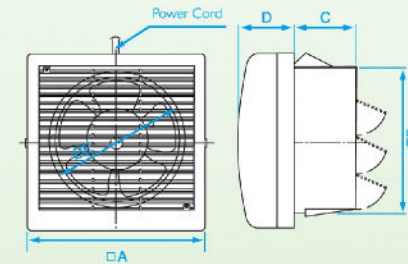

MODEL NO.		A	B	C	D	E	Installation Size
15WHB07	mm	224	177	85	72	160	φ 186-188
	inch	8.8	7.0	3.3	2.8	6.3	φ 7.32-7.40
20WHB07	mm	288	239	85	74	208	φ 247-250
	inch	11.3	9.4	3.3	2.9	8.2	φ 9.72-9.84

(只需一人)可在室內完成所有安裝和拆卸工序，省時方便。
Only one person can install and remove the fan inside the rooms for easy installation and cleaning.

型號 Model	15WHB07	20WHB07
安裝孔直徑 Diameter of Installation Hole	186-188mm	247-250mm
建議安裝玻璃厚度 Recommended Glass Thickness	3-7mm	3-7 mm

掛牆式抽氣扇 Wall Mount Type

特點 FEATURES HIGHLIGHT (For 25AUFA07)



25AUFA07

- 1 多孔鋁質過濾網，表面經易潔塗層處理
Perforated Aluminum Filter with Easy Clean Coating
- 2 HP (Half-Pitch) 馬達
HP (Half-Pitch) Motor
- 3 嶄新扇葉設計
Advanced Blade Design
- 4 大容量承油杯
Large Capacity Oil Cup

1 卓越排氣功能 EXCELLENT EXHAUST PERFORMANCE

新型號能承受高靜壓，在20Pa時，此抽氣扇所承受的風量與目前的型號比較(25DLC)增加大約10%。因此，更適用於抵受勁風的建築物，特別是高樓大廈。
This new fan is sustainable to high static pressure. At 20Pa, its air volume can increase around 10% when compared with the current model (25DLC), so it is more suitable for the buildings exposing strong breeze, especially in high rise buildings.

2 HP (Half-Pitch) 馬達 HP (HALF-PITCH) MOTOR

高效馬達配備潤滑充足的軸承裝置，大大增加產品耐用性，加強節能效果。
The highly efficient motor equipped with well lubricated bearing that prolongs the product durability and enhances energy saving.

3 易潔塗層-簡易清潔 EASY CLEAN COATING - CONVENIENT

可拆式鋁質過濾網，經"Hydrophobic"易潔塗層處理。易潔塗層是一種氟化合物，能減低水份及油份跟表面的接觸。這種物料的表面張力較低，從而使油滴下來而不會黏著。
The perforated aluminum filter is processed with an easy-clean coating named "Hydrophobic Coating". It is basically a paint composed of fluorine compound particles that have small affinity with water or oil. This material has low surface tension allowing oil droplets falling on without adhering to the materials.



註：繪圖圖像，只作說明用途
Note: this is image pictures and for easy understanding only

4 大容量承油杯 LARGE CAPACITY OIL CUP

可拆式承油杯備有油量顯示，其大容量設計可減少處理積油的次數。
The detachable oil cup with obvious oil indicator possesses large volume capacity that facilitates maintenance and reduces the frequency of oil disposal.



25AUFA07

單位 unit: 毫米 mm

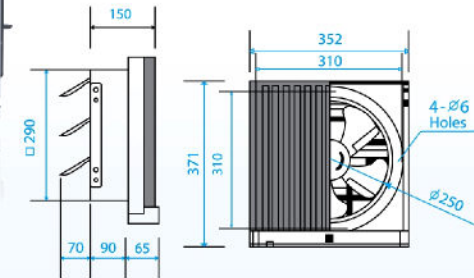

● 適合一般廚房使用
Suitable for kitchen

● 多孔鋁質過濾網
Perforated Aluminum Filter

● 易潔塗層 (過濾網)
Easy Clean Coating (filter)

● 卓越排氣功能
Excellent Exhaust Performance

● 嶄新扇葉設計
Advanced Blade Design

● HP (Half-Pitch) 馬達
HP (Half-Pitch) Motor

● 大容量承油杯
Large Capacity Oil Cup

● 油量顯示
Oil Indicator

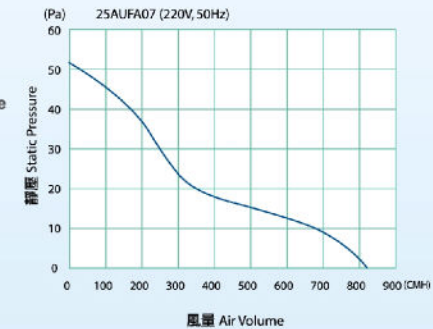

型號 Model No.	頻率 Hz	耗電量 Consumption [W]	轉速 Rotation Speed [R.P.M.]	風量 Air Volume [CMH]	噪音 Noise [dB(A)]	安裝尺寸 Installation Size [mm]	淨重 Net Weight [kg]
25AUFA07	50	34	1,100	835	42	300 X 300	2.8



20DLC07 (8") **25DLC07 (10")** **30ALF07 (12")**

單位 unit: 毫米 mm

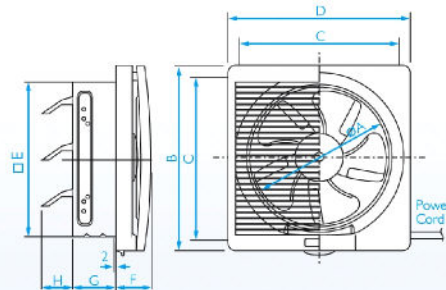

- 適合一般廚房使用
Suitable for kitchen
- 面罩置有油杯
Oil cup equipped on orifice
- 前置安全網，安全美觀
Attached front louver for safety and better outlook
- 符合防水安全規格 IPX4 (室外)
Comply with IPX4 (Outside)

MODEL NO.		A	B	C	D	E	F	G	H	Installation Size
20DLC07	mm	200	306	260	302	240	68	90	80	□ 250
	inch	7.87	12.05	10.24	11.89	9.45	2.68	3.54	3.15	□ 9.84
25DLC07	mm	250	358	310	352	290	63	90	63	□ 300
	inch	9.84	14.02	12.20	13.86	11.42	2.48	3.54	2.48	□ 11.81
30ALF07	mm	300	400	360	400	340	63	90	78	□ 350
	inch	11.81	15.75	14.17	15.75	13.39	2.48	3.54	3.07	□ 13.78



電動百葉板開關設計
Electrically Operated Shutter
(只適用於Only: 20DLC07 / 25DLC07)



20AUH07 (8") **25AUH07 (10")** **30AUH07 (12")**

單位 unit: 毫米 mm

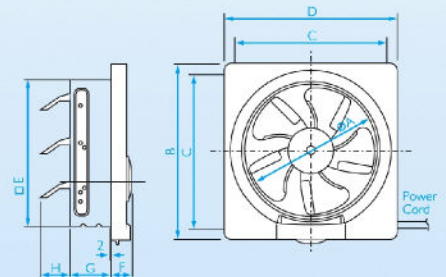

- 適合一般廚房使用
Suitable for kitchen
- 面罩置有油杯
Oil cup equipped on orifice
- 符合防水安全規格 IPX4 (室外)
Comply with IPX4 (Outside)
- 嶄新扇葉設計(30型號除外)
Advanced blade design (except 30 model)

MODEL NO.		A	B	C	D	E	F	G	H	Installation Size
20AUH07	mm	200	308	260	302	240	52	90	80	□ 250
	inch	7.87	12.05	10.24	11.89	9.45	2.05	3.54	3.15	□ 9.84
25AUH07	mm	250	358	310	352	290	38	90	63	□ 300
	inch	9.84	14.02	12.20	13.86	11.42	1.50	3.54	2.48	□ 11.81
30AUH07	mm	300	406	360	402	340	38	90	78	□ 350
	inch	11.81	15.98	14.17	15.83	13.39	1.50	3.54	3.07	□ 13.78



15AAQ107 (6")

單位 unit: 毫米 mm

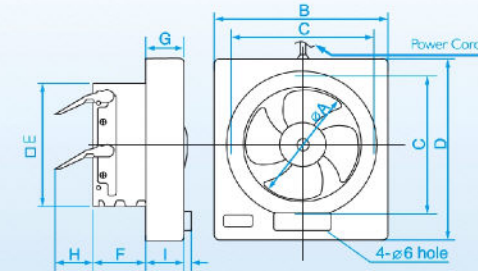

- 適合一般廚房使用
Suitable for kitchen
- 面罩置有油杯
Oil cup equipped on orifice
- 符合防水安全規格 IPX4 (室外)
Comply with IPX4 (Outside)

MODEL NO.		A	B	C	D	E	F	G	H	I	Installation Size
15AAQ107	mm	150	240	195	254	170	75	65	54	52	□ 175
	inch	5.91	9.45	7.68	10.00	6.69	2.95	2.17	2.13	2.05	□ 6.89

浴室用抽氣扇 Bathroom Type



10BAQ107 (4")

- 適合沒有窗口之浴室使用
Suitable for bathroom without window
- 符合防水安全規格 IPX4 (室外)
Comply with IPX4 (Outside)
- $\varnothing 100\text{mm}$ 可駁喉式掛牆抽氣扇
 $\varnothing 100\text{mm}$ duct-type wall mount ventilating fan

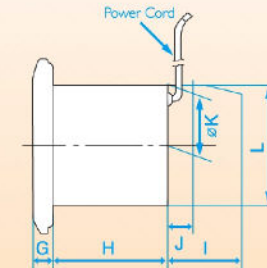
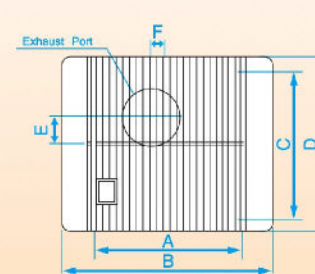

MODEL NO.		A	B	C	D	E	F	G	H	I	J	K	L
10BAQ107	mm	180	260	178	210	34	20	24	140	90	30	74	150x200
	inch	7.09	10.24	7.01	8.27	1.34	0.79	0.94	5.51	3.54	1.18	2.91	5.9x7.87

浴室換氣暖風機 Thermo Ventilator

特點 FEATURES HIGHLIGHT

1 乾衣功能 Clothes Drying

即使在潮濕的日子，只需把衣服掛在浴室中，輕按開關，浴室中循環的熱空氣，會把衣服弄乾，並不會損害衣物纖維。
Even in humid days, just hangs your clothes in the bathroom and then switches on the equipment, circulated airflow will dry your clothes thoroughly; also, it would not damage clothes fiber.

2 換氣功能 Ventilating

使用渦輪扇葉達致高靜壓效果。有效抽出不潔空氣及氣味，並除去沐浴時帶來的濕氣，防止霉菌生長。
By using sirocco fan, it is able to sustain high static pressure. It can exhaust uncomfortable air and odor out of the bathroom, restrict growth of mold, mildew and mite by removing moisture from bathroom.

3 暖氣功能 Heating

換氣暖風機能溫暖浴室，可確保冬天時浴室的舒適溫度，為長者及兒童帶來溫暖的沐浴時刻。
With ventilator, it can heat up the bathroom and maintain warm temperature even in winter season. Both the elderly and children in your family can experience a comfortable bath.

4 循環功能 Circulation

配合靜音設計，夏天時可作風扇使用，即使在狹窄的浴室中都能感受到清涼感覺，維持浴室空氣流通。
In Summer, act as an electric fan that let you have cool feeling even in the airtight bathroom. It maintains air circulation throughout the bathroom that comforts your feeling.

5 操作簡易 Simple Operation

只需把按鈕輕輕一按，便能操作所有功能。
All functions can be operated by just simply pressing of wall mount switch panel or remote controller.

控制面板 Switch Panel

- 關掉所有功能
Turn off all operations
- 浴室換氣操作
Ventilation for bathroom
● 高 / 低檔選擇
Hi / Lo selection
● 持續運作生效
Continuous running enabled
- 涼風乾燥功能
Drying function by cool air
● 高 / 低檔選擇
Hi / Lo selection
● 持續運作生效
Continuous running enabled
- 暖風乾燥功能
Drying function by warm air
● 高 / 低檔選擇
Hi / Lo selection

- 暖氣功能
Heating function
● 使用自動暖氣功能，浴室瞬間變得溫暖
Instant heat up of the bathroom by "Auto" mode
● 高低檔選擇
Hi / Lo selection
- 五種風向選擇
5 selections of air direction
● 持續搖擺送風
Continuous swing of airflow
- 集中或擴散送風模式選擇
Selection of spot or wide air mode
- 預校時間掣
Pre-set timer
● 暖氣機連續運作3小時後，會自動關掉
Heater will be turned off after continuous run 3 Hours
● 換氣及循環功能可連續運作
Continuous operation for ventilation & circulation function

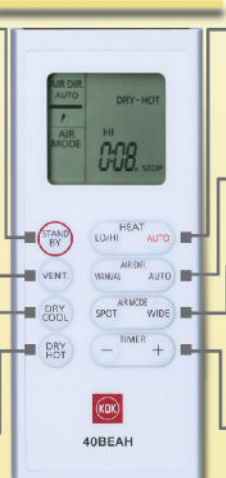

* 40BEAH 遙控器
Remote controller for 40BEAH

NEW

珍珠白色
Pearl White



40BEAH (PTC型號 PTC Type)

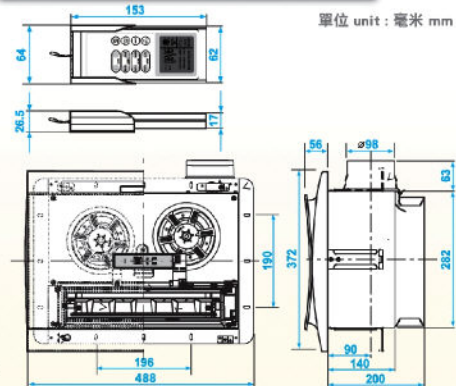

* PTC = Positive Temperature Coefficient
(正溫度係數)

- 新出的PTC型號可根據不同喜好調整送風方向和角度，溫暖整個浴室，令沐浴更舒適。
- The newly launched PTC type with adjustable air direction and modes enhance the flexibility of application.

安裝孔尺寸 Installation Hole Size	mm	290 x 400
英寸	inch	11.42 x 15.75
導管直徑 Duct Diameter	mm	φ100
英寸	inch	φ 4



送風方向 Air Direction

可調較送風 Adjustable Air Direction

提供五種垂直風向，任君選擇。
There are five selections for air direction that allows you to choose the airflow as desired.

自動搖擺送風 Auto Swing Operation

導風板的搖擺動作，把空氣吹送至浴室的每個角落。
With this mode, the baffle plate swings to enable the airflow to reach all corners of the bathroom.



送風模式 Air Modes

集中送風 Spot Air mode

把暖風集中，於短時間內提升局部位置所需溫度。
Warm air is centralized that desired temperature at spot area can reach in a short period.

擴散送風 Wide Air Mode

擴散送風模式令空氣於整個浴室遍佈吹送。
With the wide air mode, circulation air is adjusted to spread widely to the whole bathroom.



自動暖氣功能 "Auto-heat Mode"

可於 1.5分鐘內把浴室升温至攝氏30度
It can instantly warm up the bathroom to 30°C in only 1.5 minutes

自動暖氣功能 "Auto-heat Mode"
面積 Area : 1.6米 x 1.6米 x 2.3米
始溫 Initial Temperature : 攝氏 5度

40BEAH 乾衣功能測試 40BEAH Clothes Drying Test

配合最新送風角度，乾衣功能得以大大提升
With the newly advanced air direction, the clothes drying performance is greatly increased.

浴室面積：
1.6米 x 1.6米 x 2.3米
Area of a bathroom:
1.6 m x 1.6 m x 2.3 m

濕度：60%
Humidity: 60%

濕潤衣服：3.5公斤
Weight of wet clothes: 3.5 kg

結果：PTC型號可於**104分鐘**把衣服弄乾而所需電費只是**\$4.2**
Result: By using the PTC type, it takes only **104 minutes** to dry the clothes and electrical charge* just costs **\$4.2**

浴室寶運作模式：乾燥功能
Operation mode of PTC type:
"Dry-hot" mode

*電費 =
每度電(HK\$1/千瓦小時) x 消費電功率(千瓦) x 時間(小時)
*Electrical charge =
Electrical Rate (HK\$1 / kWh) x Power Consumption (kW) x Timer (hr)

氣溫：攝氏20度
Temperature: 20°C



40BDAH (PTC型號 PTC Type)

單位 unit: 毫米 mm

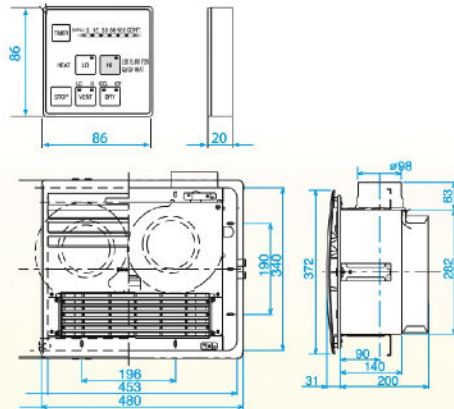

- 珍珠白 Pearl White
- 香檳金 Champagne Gold

安裝孔尺寸	mm	290 x 400
Installation Hole Size	inch	11.42 x 15.75
導管直徑	mm	ø 100
Duct Diameter	inch	ø 4



速暖功能 Heating (Hot Start)

'速暖'功能可於短時間將浴室內溫度上升至舒適狀態^{*1}。高效能的PTC 加熱器能於6分鐘將浴室瞬間升溫至30°C^{*2}。

"Hot Start" function warms up the room to a comfortable condition within a short time^{*1}. High capacity PTC heating element can instantly warm up the bathroom to 30°C^{*2} in only 6 minutes.



抗菌過濾網 Allergy Buster Filter

抗菌過濾網能淨化在易滋生細菌的浴室中起到抗菌作用，能帶給你一個健康和乾淨的浴室環境。

Equipped with "Allergy-buster Filter", it can purify the air inside the bathroom that maintains a healthy and clean environment.

40BDAH 乾衣功能測試 40BDAH Clothes Drying Test

浴室面積：
1.6米 x 1.6米 x 2.3米
Area of a bathroom:
1.6 m x 1.6 m x 2.3 m

濕潤衣服：3.2公斤
Weight of wet clothes: 3.2 kg

浴室實運作模式：乾燥功能
Operation mode of PTC type:
"Dry-hot" mode

氣溫：攝氏20度
Temperature: 20°C

濕度：60%
Humidity: 60%

結果：PTC型號可於**136**分鐘把衣服弄乾而所需^{*}電費只是**\$5.5**
Result: By using the PTC type, it takes only **136** minutes to dry the clothes and the electrical charge^{*} just costs **\$5.5**

^{*}電費 = 每度電(HK\$1/千瓦小時) x 消費電功率(千瓦) x 時間(小時)
^{*}Electrical charge = Electrical Rate (HK\$1 / kWh) x Power Consumption (kW) x Timer (hr)

註：
*1 速暖功能僅在20°C以下並於產品運作時發揮作用。
*2 房間尺寸為1.6米 x 1.6米 x 2.3米。
Remark: *1 "Hot Start" only functions when it is below 20°C during operation
*2 Room size is 1.6m x 1.6m x 2.3m.



40BFBH (鹵素加熱型號 Halogen Type)

單位 unit: 毫米 mm

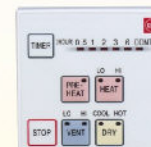
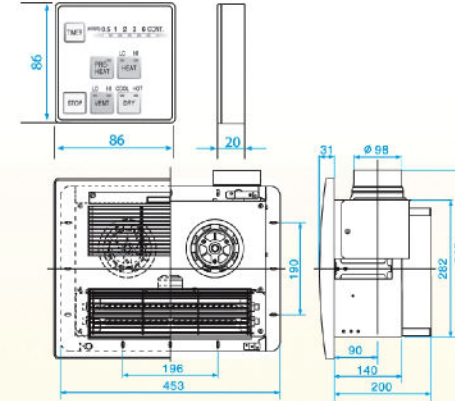

- 珍珠白 Pearl White
- 銀色 Silver

安裝孔尺寸	mm	290 x 400
Installation Hole Size	inch	11.42 x 15.75
導管直徑	mm	100
Duct Diameter	inch	4



預熱功能 Heating (Pre-Heat)

沐浴前把預熱功能一按，可於短時間內讓浴室的溫度快速上升，即使在嚴寒中亦能令你、長者和兒童溫暖舒適的沐浴時刻。

Before taking bath, turns on "Pre-heat" function to warm up the bathroom immediately. You, as well as the elderly and children of your family, can experience a real warm bath in winter with ease by switching button to "Pre-heat" function.



● 預熱功能
Heating (Pre-Heat)

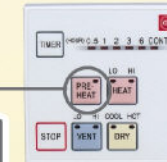

可選擇式排氣口 Selectable Ventilation Outlet

兩個可供選擇的排氣出口，配合不同安裝環境，更具彈性

Two exhaust holes selection provides more flexibility for installation in various conditions.

排氣口 Outlet (A)

排氣口 Outlet (B)

- 使用排氣口(B)，風量會相對較低
Air volume is reduced at outlet (B)

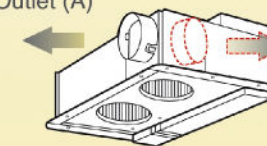

● 安全可靠 Safety Concern

* (只適用於40BFH)
(Only for 40BFH)



		40BEAH (PTC 型號)	40BDAAH (PTC 型號)	40BFBH (鹵素加熱型號)	
功能 Function	暖氣 Heating	1.5分鐘內把浴室升溫至攝氏30度 Warm up the bathroom to 30°C in only 1.5 minutes	速熱效能，6分鐘升溫至攝氏30度 "Hot Start"; warm up the room to 30°C in 6 minutes	預熱功能，短時間使浴室變暖 "Pre-heat" before taking bath to warm up the room	
	乾燥 Dry	高、低、自動 Hi - Lo - Auto 配合風向調節， 達到最佳效果 Achieve preferable effect by adjustment of air mode.	高、低 Hi - Lo 暖風與身體直接接觸， 以減少溫度差 Temperature difference to human body is minimized	高、低 Hi - Lo 透過反射板的 輻射加快取暖效果 Warm up human body by radiation of infra-red light	
	換氣 Ventilation	高、低 Hi - Lo	高、低 Hi - Lo	高、低 Hi - Lo	
	時間制 Timer	5-720 Cont. (分鐘 Minute)	5, 15, 30, 60, 180, Cont. (分鐘 Minute)	0.5, 1, 2, 3, 6, Cont. (小時 Hour)	
效能 Performance	風量 Air Volume	換氣 Ventilation	175CMH	160CMH	160CMH
		循環 Circulation	170CMH	185CMH	210CMH
	噪音 Noise	換氣 Ventilation	36 dB	36 dB	37 dB
		暖氣 Heating	46 dB	46 dB	39 dB
最高耗電量 Max. Wattage	2,450W	2,450 W	1,500 W		
過濾網 Filter	抗塵過濾網可抑制99% 霉菌等的過敏原 allergen-buster filter inhibits virus & bacteria up to 99%		防塵過濾網可防止 微塵在室內循環 Dust filter filtrates particles inside the room		
馬達 / 扇葉數目 No. of Motor / Blade	2 / 2				
排氣口數目 Exhaust Outlet	1		2		
加熱器壽命 Heater Life Time	在正常操作環境下，可達 9,000 小時 Under the normal operation situation, it can be up to 9,000 hours		在正常操作環境下，可達 7,000 小時 Under the normal operation situation, it can be up to 7,000 hours		

■ 天花板式抽氣扇 Ceiling Mount Type

特點 FEATURES HIGHLIGHT

1 長壽命 Long Life

- 獨特設計的馬達以及高度潤滑的滾珠軸承，可減低溫度上升，從而增加馬達壽命及延長產品之耐用性。
- The unique design of new motor, incorporates with well-lubricated ball bearings, temperature rise is reduced that can increase the motor life time and prolongs the product durability.

2 性能卓越 High Efficiency

- 錐形扇葉設計有效控制了扇葉週圍產生的亂流，實現了扇葉整體強力流暢的換氣功能及減低噪音。
- 獨特的焊縫加工技術，提高了主機外觀的強度及密封性。
- 備有防逆流百葉，增強了密封性。
- Taper blade design effectively controls the air turbulence surrounding the blade. That achieves the strong and smooth ventilation performance, as well as reduces the noise level, by whole of the blade.
- Seam-processed casing ensures strength and hermetic sealing.
- Reverse flow prevention shutter results in further improvement of air tightness.

3 超靜音運作 Super Low Noise Operation

(只適用於17CUF)(Only for 17CUF)

- “雙重面罩”的獨創結構能使抽氣扇所產生的噪音傳輸減到最少。這技術可進一步使操作噪音降低至30分貝以下，並為你造舒適的環境。
- Distinctive structure "Double Orifice" minimizes the transmission of noise from fan and motor to exterior. This technology further reduces the operation noise to incredibly low level below 30dB(A) through "Resonance-Noise-Absorption" which creates a tranquility and silent environment for your life.

4 簡易安裝 Easy Installation

- 盒式匹配器，使進行通風管道的連接工作，更方便快捷。
- Cassette type discharge adaptor facilitating installation of the product, as well as ductwork connecting.

5 簡易維修 Easy Maintenance

- 一按式入風面板，可以簡單地進行安裝及拆卸工作，方便清潔。
- One touch louver allows installation and removal of louver by finger touch.

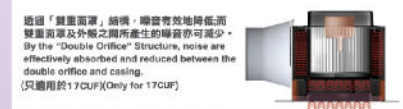

■ 通風道作業用附件 Accessories for Ductwork

通風道罩 Duct Cap 不銹鋼 Stainless Steel

VGX100K

VGX150K

VCX100K

VCX150K



管道蓋 Pipe Hood 不銹鋼 Stainless Steel

MGX100K

MGX150K

MCX100K

MCX150K



馬達直徑 Duct Diameter	ø100		ø150	
	Duct Cap	Pipe Hood	Duct Cap	Pipe Hood
有濾網 With Net	VGX100K	MGX100K	VGX150K	MCX150K
無濾網 Without Net	VCX100K	MCX100K	VCX150K	MCX150K

新
NEW



塑膠製
Plastic Type

外殼 Casing - 金屬 Metal
扇葉 Blade - 塑膠 Plastic
面罩 Louver - 塑膠 Plastic

- 超靜音運作
Super low noise operation
- 長壽命滾珠軸承式馬達
Long life ball bearing motor
- 錐形渦輪扇葉
Taper blade sirocco fan
- 雙重面罩設計
Double orifice design
- 預先裝上電源接線
Pre-installed power cord

17CUF

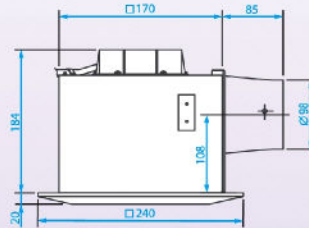
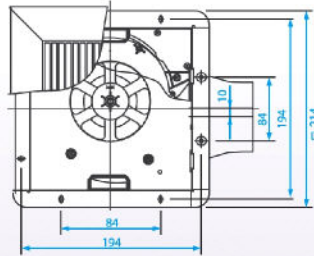

單位 unit : 毫米 mm

型號 Model	17CUF	
安裝孔尺寸 Installation Hole Size	mm	177 x 177
	inch	6.97 x 6.97
導管直徑 Duct Diameter	mm	φ 100
	inch	

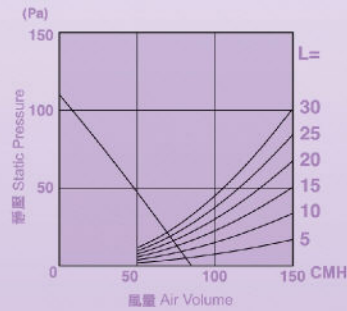

型號 Model No.	頻率 Hz	耗電量 Consumption [W]	風扇轉速 Fan Speed [R.P.M.]	風量 Air Volume [CMH]	噪音 Noise [dB(A)]	重量 Weight [kg]
17CUF	50	11	790	85	26	1.9

24CMHA

24CMUA

24CMDA

單位 unit : 毫米 mm

- 可取喉式天花板抽氣扇
Duct-type ceiling mount ventilating fan

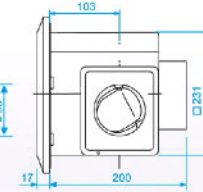
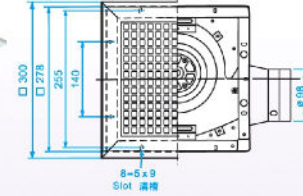

鋼製
Steel Type

外殼 Casing - 金屬 Metal
扇葉 Blade - 金屬 Metal
面罩 Louver - 金屬 Metal

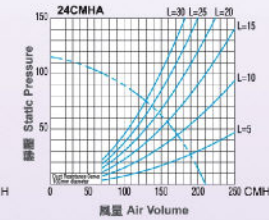
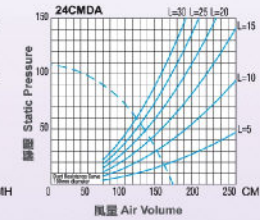
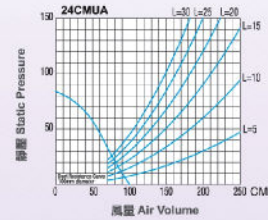

27CMDA

27CMHA

單位 unit : 毫米 mm

- 可取喉式天花板抽氣扇
Duct-type ceiling mount ventilating fan

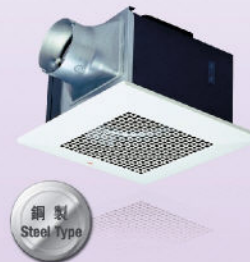
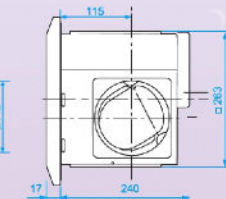
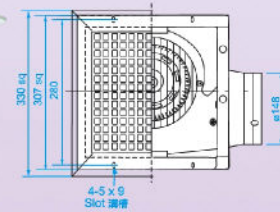

鋼製
Steel Type

外殼 Casing - 金屬 Metal
扇葉 Blade - 金屬 Metal
面罩 Louver - 金屬 Metal

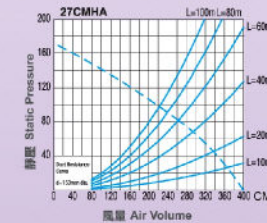
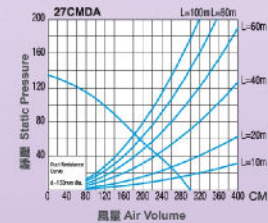

型號 Model	24CMUA / 24CMDA / 24CMHA		27CMDA / 27CMHA	
安裝孔尺寸 Installation Hole Size	mm	□ 240	mm	□ 270
	inch	□ 9.46	inch	□ 10.64
導管直徑 Duct Diameter	mm	φ 100	mm	φ 150
	inch	φ 4	inch	φ 6

特點 FEATURES HIGHLIGHT(for DC Ceiling Mount Type)

① 節能 - 直流馬達 Energy Saving - DC Motor

● 能源效益 Consumption Reduction

抽氣扇採用直流馬達，可減少電力消耗，節省能源。
直流馬達的溫度升比交流馬達低，所以直流馬達的壽命比交流馬達相對較長。
These fans are adopted with Direct Current (DC) Motor to reduce power consumption in order to save energy.
Temperature rise of DC motor is comparatively lower than AC motor that lifetime of DC motor is longer than AC motor accordingly.

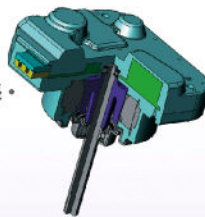

	24JRA	24CMDA
馬達類型 Motor Type	直流 DC	交流 AC
靜壓 Static Pressure [Pa]	0	0
風量 Air Volume [CMH]	160	165
在51 Pa的耗電量 Consumption at 51 Pa [W]	8.3	18
能源效益 Energy Efficiency [CMH / Watt]	19.3	9.2

註：於220V 50Hz時的數據。數據僅作參考用。
Remark: Values in table is at 220V 50Hz.

- 熱輻射高 High Thermal Radiation
- 驅動溫度低 Lower Drive Temperature
- 耐用 Long Life
- 可靠性高 High Reliability
- 功率損耗低 Low Power Loss

② 風量 - 恆穩輸出 Air Flow - Constant Output

● 智能技術 Intelligent Technology

抽氣扇採用智能技術，以恆穩的風量運作，不會因為彎管(elbows)和其它影響風量的因素而降低。
基本上，當風扇面對靜壓時，其轉速會自動增加，以確保預設的風量而達到肯定的功效及抽氣表現。
These fans are equipped an intelligent technology, by which the fans perform at a constant airflow regardless of elbows and factors that might affect the performance.
Basically, when the fan faces static pressure, its speed is automatically increased to ensure the desired air flow and allows the fan to perform as rated.

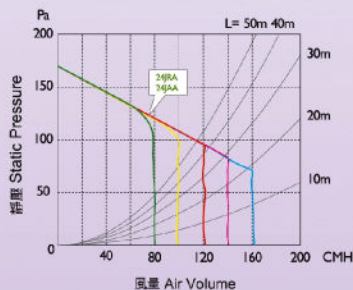

	靜壓 Static Pressure	24JRA	24CMDA
風量 Air Volume	0Pa	160	165
	51Pa	160	125

③ 壓阻與管之關係 Relationship Between Static Pressure and Duct Work

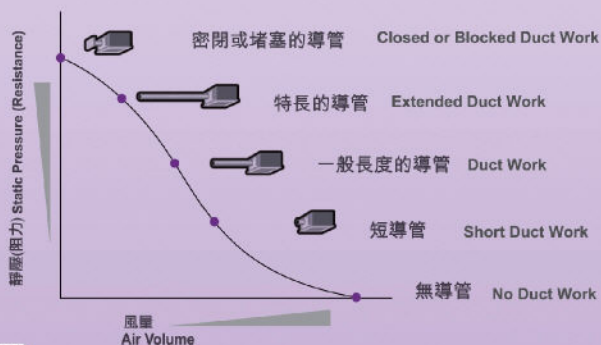

④ 延遲定時器 - 9段選擇 Delay Timer - 9 Variables

● 便利生活 Convenience

當抽氣扇被關掉或在預設的時間內，沒有感應到任何動作，它會轉至預設的低風速運作。
These fans are equipped with a Delay Timer which can be adjustable from 0.5 to 60 minutes. As the fan is switched off or without any motion detected after a period of time set by the user, it will return to the present low air volume level.



延遲定時器 Delay Timer

- 設定時間 [分鐘] 0.5, 1, 2, 3, 5, 10, 20, 30, 60

⑤ 風量 - 6段選擇 Air Volume - 6 Variables

● 彈性選擇 High Flexibility

抽氣扇設有多段風量調校，可選擇以80-160 CMH或停止程式(STOP mode)運行，每當啟動開關或經紅外線感應器啟動時，風量會提升至最高160CMH。
These fans are equipped with Variable Speed Control that allows the fans to run at preset lower level of 80-160 CMH or "STOP mode", then be elevated to a maximum of 160 CMH when the switch is turned on, or activated via the Motion Sensor.



風量調校掣 Air Volume Adjustment Switch

- 調校範圍 [CMH] STOP / 80 / 100 / 120 / 140 / 160

⑥ 感應器 - 紅外線感應 Sensor - Motion Sensor

● 自動運作 Auto Operation

全新抽風扇設有“紅外線感應”，可在您進入房間時自動啟動，離開後自動關上。
Just updated with the "Motion Sensor" ventilating fan which can be switched on automatically when you enter the room and switched off itself again after you leave.

⑦ 局部換氣及全面換氣的運作 The operation of spot ventilation and whole ventilation

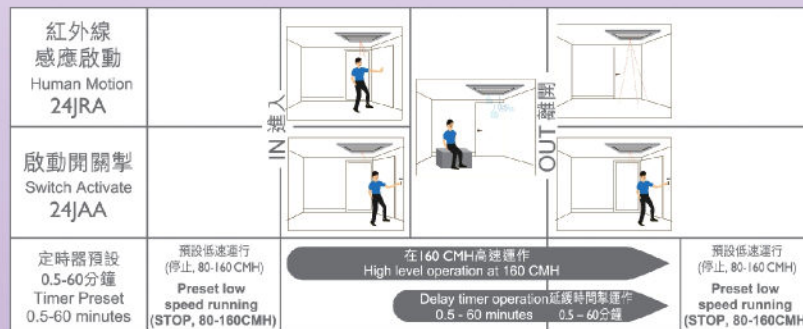



24JRA



24JAA

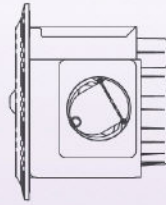
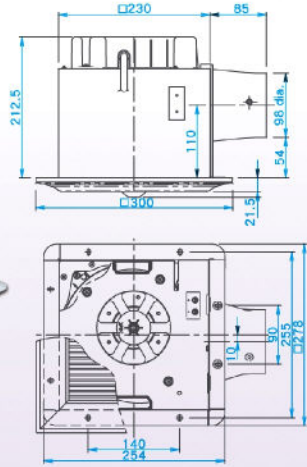

單位 unit : 毫米 mm

- 直流馬達 DC motor
- 恆穩風量 Constant airflow
- 多段風量選擇 Variable air volume
- 延緩時間掣 Delay timer
- 紅外線感應自動運作 Auto operation by motion sensor
- 消音結構 Resonance-Noise-Absorption Structure
- 錐形離心扇葉 Taper blade sirocco fan
- 附設電源線 Pre-installed power cord

● 自動運作 Auto Operation

全新抽氣扇設有“紅外線感應”可在您進入房間時自動啟動，離開時自動關上。
Just update with the 'Motion Sensor' ventilating fan which can be switched on automatically when you enter the room and switched off itself again after you leave.

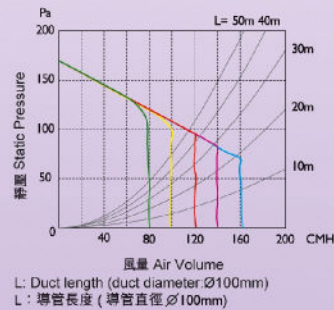

型號 Model No.	Hz	耗電量 Consumption [W]	風扇轉速 R.P.M.	風量 Air Volume [CMH]	噪音 Noise [dB(A)]	淨重 Net Weight [公斤] [kg]	安裝尺寸 Installation Hole Size [毫米] [mm]	導管直徑 Duct Diameter [毫米] [mm]
24JRA	50	8.3	725	0 Pa	31	3.6	240x240	Ø 100
				51 Pa				
				63 Pa				

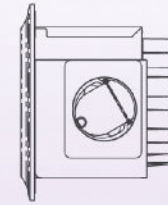
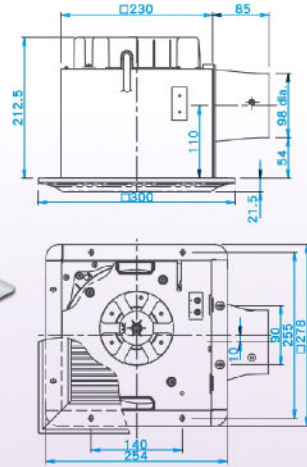

單位 unit : 毫米 mm

- 直流馬達 DC motor
- 恆穩風量 Constant airflow
- 多段風量選擇 Variable air volume
- 延緩時間掣 Delay timer
- 消音結構 Resonance-Noise-Absorption Structure
- 錐形離心扇葉 Taper blade sirocco fan
- 附設電源線 Pre-installed power cord

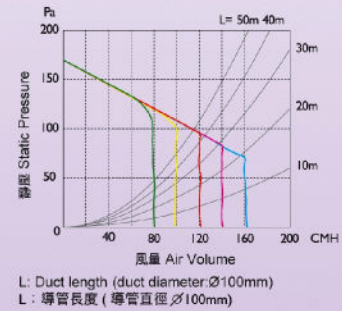

型號 Model No.	Hz	耗電量 Consumption [W]	風扇轉速 R.P.M.	風量 Air Volume [CMH]	噪音 Noise [dB(A)]	淨重 Net Weight [公斤] [kg]	安裝尺寸 Installation Hole Size [毫米] [mm]	導管直徑 Duct Diameter [毫米] [mm]
24JAA	50	7.5	725	0 Pa	31	3.6	240x240	Ø 100
				51 Pa				
				63 Pa				

抽油煙機 Range Hood



712K

輕觸式



- 易拆式設計 (可拆下扇葉清洗)
Easy clean design (Detachable fan for cleaning)
- 超靜音運作
Whisper silent operation
- 千翼渦輪扇葉，適合高靜壓環境使用
Sirocco fan overcomes high static pressure environment
- 120mm 纖薄機身
Slim design of 120mm
- 輕觸式開關
Soft touch panel operation
- 延遲關機功能
Prolonged off-timer

711K

輕觸式



- 易拆式設計 (可拆下扇葉清洗)
Easy clean design (Detachable fan for cleaning)
- 超靜音運作
Whisper silent operation
- 千翼渦輪扇葉，適合高靜壓環境使用
Sirocco fan overcomes high static pressure environment
- 120mm 纖薄機身
Slim design of 120mm
- 左/右扇葉獨立開關
Left / right separate operation

單位 unit: 毫米 mm

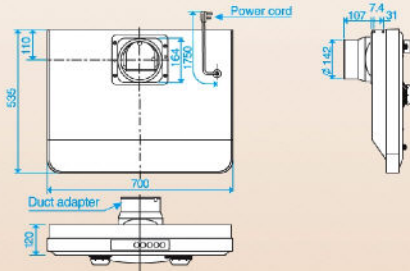

風閘 Air Curtain



- 適合安裝於10尺高樓底
Applicable for 10ft ceiling height
- 簡便的安裝；既可掛在牆上，亦可懸掛在房間天花板上
Simplified installation; either wall-hang or suspended from the ceiling of a room
- 附設導風板可以容易地調整送風的方向
Air deflection vents easily adjust air flow direction
- 開關設於機體上，可提供高、低兩種風速
2-speed changeover (Hi, Lo and off) is available with a push-button switch provided in the unit

10ESK

10ELK

單位 unit: 毫米 mm

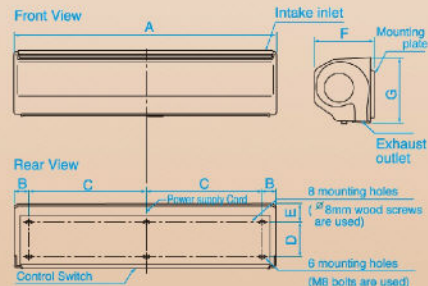

MODEL NO.	A	B	C	D	E	F	G
10ESK	mm	900	50	400	120	63	205 226
10ELK	mm	1,200	200	400	120	63	205 226

乾手機 Eco-Dry (Hand Dryer)



T09AB

單位 unit: 毫米 mm

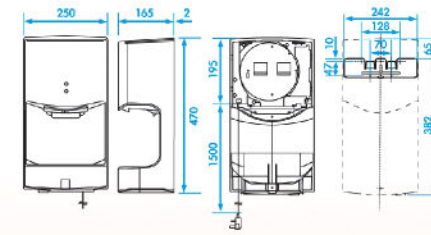

T09BB

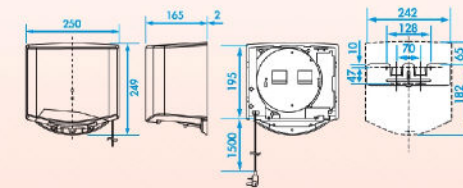

- 強勁風速約120m/s
Powerful air velocity of 120m/s
- 紅外線自動感應
Infra-red motion sensor
- 獨特盛水器設計*
Unique drain pan and water tray*
- 超級抗敏過濾網
Super Alleru-Buster Filter
- 過熱停止功能
Auto-stop feature for overheat protection
- 安全指示燈功能
Safety check light function
- 防菌外殼物料
Anti-bacteria casing material
- 附設懸掛鐵片
Supply with metal mounting plate
- 發熱器開關掣
Heater ON/OFF Switch

*只適用於 T09AB For T09AB only

What is Super Alleru-Buster?

使用超級抗敏過濾網，可抑制多種不同過敏原的活動 Super Alleru-Buster can inhibit up to several types of allergen

石碳離聚合物·抗氧化物質
Phenolic Polymer · Polyphenol

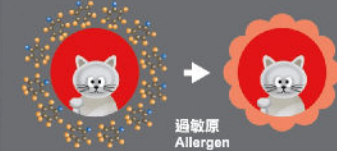

SUPER alleru-buster
包裹過敏原 抑制其活動 inhibit allergens

Testing Organization: The Osaka Municipal Technical Research Institute
Testing Method: To measure the level of reduction in cat's dandruff by Enzyme-linked Immuno Sorbent Assay.
試驗機構：大阪市立工業研究所
試驗方法：採用酵素免疫測定方法，測試貓毛屑的減少程度

規格 · SPECIFICATIONS

■ 窗口式 Window Mount Type

型號 Model	風量 Air Volume [CMH] / [CFH]	風扇轉速 Fan Speed [R.P.M.]	噪音水平 Noise Level [dB(A)]	耗電量 Power Consumption [Watt]	淨重 Net Weight [Kg]	
15WUE07	210 (7,420)	1,524	34	7.7	0.9	
20WUE07	420(14,830)	1,205	39	17	1.1	
15WULA07	192 (6,780)	1,524	38	7.7	0.9	
20WULA07	342 (12,080)	1,093	39	16	1.7	
15WJA07	高High	220 (7,770)	1,960	47	27	2.4
	低Low	165 (5,830)	1,460	38	24	
15WHB07	200 (7,062)	1,871	44	17	1.6	
20WHB07	444 (15,680)	1,300	42	20	2.0	

■ 掛牆式 Wall Mount Type

型號 Model	風量 Air Volume [CMH] / [CFH]	風扇轉速 Fan Speed [R.P.M.]	噪音水平 Noise Level [dB(A)]	耗電量 Power Consumption [Watt]	淨重 Net Weight [Kg]
25AUF07	835 (29,488)	1,100	42	34	2.8
15AAQ107	290 (10,241)	1,480	31	15	1.4
20DLC07	560 (19,776)	1,210	38	22	2.5
25DLC07	882 (31,147)	1,060	40	29	2.9
20AUH07	580 (20,480)	1,245	38	22	2.0
25AUH07	920 (32,490)	1,125	39	29	2.4
30AUH07	1,200 (42,380)	1,030	39	29	2.7
30ALF07	935 (33,020)	905	39	29	3.1

■ 浴室用抽氣扇 Bathroom Type

型號 Model	風量 Air Volume [CMH] / [CFH]	風扇轉速 Fan Speed [R.P.M.]	噪音水平 Noise Level [dB(A)]	耗電量 Power Consumption [Watt]	淨重 Net Weight [Kg]
10BAQ107	77 (2,719)	1,250	40	15	1.7

■ 浴室換氣暖風機 Thermo Ventilator

型號 Model	風量 Air Volume [CMH] / [CFH]		耗電量 Power Consumption [Watt]	排氣管 Ducting [mm]	淨重 Net Weight [Kg]
	高 High	低 Low			
40BEAH	175 (6,180)	95 (3,355)	2,450	∅ 100	8.5
40BDAH	160 (5,650)	95 (3,355)	2,450	∅ 100	8.5
40BFBH	160 (5,650)	95 (3,355)	1,500	∅ 100	8.5

■ 天花板式 Ceiling Mount Type

型號 Model	風量 Air Volume [CMH] / [CFH]	排氣管 Ducting [mm]	風扇轉速 Fan Speed [R.P.M.]	噪音水平 Noise Level [dB(A)]	耗電量 Power Consumption [Watt]	淨重 Net Weight [Kg]
17CUF	85 (3,001)	∅ 100	790	26	11	1.9
24JRA	160 (5,650)	∅ 100	725	31	8.3	3.6
24JAA	160 (5,650)	∅ 100	725	31	7.5	3.6
24CMUA	100 (3,531)	∅ 100	495	26	11	3.8
24CMDA	165 (5,826)	∅ 100	670	33	18	3.8
24CMHA	210 (7,416)	∅ 100	800	38	25	3.8
27CMDA	300 (10,590)	∅ 150	520	32	26	5.6
27CMHA	400 (14,125)	∅ 150	620	38	43	5.6

■ 風隔 Air Curtain

型號 Model	速度 Speed	風速 Air Velocity [m/s]	風量 Air Volume [CMH] / [CFH]	噪音水平 Noise Level [dB(A)]	耗電量 Power Consumption [Watt]	淨重 Net Weight [Kg]
10ESK	高 High	13.0	750 (26,550)	46	72	12
	低 Low	11.1	630 (22,302)	42	62	
10ELK	高 High	13.1	1,000 (35,400)	46	96	14
	低 Low	11.0	830 (29,832)	41	74	

■ 抽油煙機 Range Hood

型號 Model	速度 Speed	風量 Air Volume [CMH] / [CFH]	耗電量 Power Consumption [Watt]	噪音水平 Noise Level [dB(A)]	靜壓 Static Pressure [Pa]	淨重 Net Weight [Kg]
712K	Super	730 (25,800)	140	53	232	17.5
	Hi	530 (18,800)	95			
	Lo	430 (15,200)	72			
711K	Hi	730 (25,800)	140	53	232	17.5
	Lo	430 (15,200)	72			

■ 乾手機 Eco-Dry (Hand Dryer)

型號 Model	風速 Air Velocity [m/s]	水箱 Water tray	耗電量 Power Consumption [Watt]	安裝方法 Installation Type	淨重 Net Weight [Kg]
T09AB	120	Yes	1,000	Wall Mount	4.3
T09BB	120	No	1,020	Wall Mount	3.6

選擇抽氣扇時，可按房間的大小而選擇適合該送風量的抽氣扇
Room size is considered when selecting appropriate Ventilating Fan.

所選抽氣扇送風量
Air volume of selected ventilating fan (立方米/小時 m³/hr)

= 房間體積 Room size (立方米 m³)

X 建議每小時換氣次數 Recommended no. of air change per hour (次/小時 n/hr)

參考資料 Reference

房間面積 Room size (平方呎/Sq. ft.)	建議型號 Recommended Model No.	10BAQ107 ● 15WJA07 ● 15WHB07 15WUE07 15WULA07 15AAQ107	● 20WHB07 20WUE07	● 20DLC07 20AUH07 25AU FA07 ● 25DLC07 25AUH07 30ALF07	30AUH07
洗手間 Toilet : 20-70(平方呎/Sq. ft.)					
洗手間或廚房 Toilet/Kitchen : 70-100 (平方呎/Sq. ft.)					
廚房 Kitchen : 100-200 (平方呎/Sq. ft.)					
其他房間 Other rooms : 180-300 (平方呎/Sq. ft.)					

● 電動百葉背板開關設計 Electrically Operated Shutter

建築物及房間類別 Type of building and room	建議每小時換氣次數 (次/小時) Recommended no. of air change per hour (n/hr)
浴室/洗手間 Bathroom/Toilet	5-10
廚房 Kitchen	15
學校課室 School Classroom	12-15
公司 Office	12-15

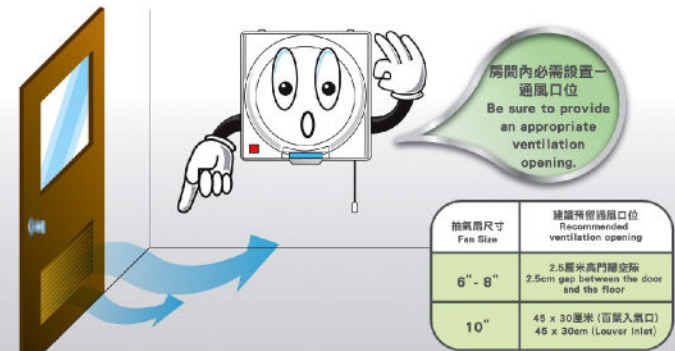

注意事項 Attention :

房間內必須設置一通風口位，使能達到有效的換氣效果。
 Be sure to provide an appropriate ventilation opening for effective ventilation.

電動百葉抽氣功能

Electric Shutter Can Work Under Stormy Weather

一般抽氣扇背板，在強風下可能無法正常開啟，因而影響抽氣扇的運作。KDK最新WJA、WHB及DLC型號系列，配備有電動百葉背板，由電動馬達帶動的背板，在強風下也能如常開啟，使抽氣扇能正常運作。當抽氣扇關閉時，電動背板亦會同時關閉，確保用戶無須再受到百葉不能緊閉引致室外污染空氣、水滴及灰塵進入室內，導致環境污染及百葉所帶來的噪音影響。

Ordinary ventilation fan does not work during windy weather since the shutter cannot be opened. KDK's newest ventilation fan series (WJA, WHB and DLC) equipped with an electric shutter which is operated by a powerful motor that can keep shutter open even in stormy weather. Fan shutter will be hold firmly once the unit is turned off, which blocks outside polluted air, rain and dust and avoiding noise problem from outside wind.

近期抽氣扇工程事例 (1997-2010)

Recent "Window Mount Types" Major Projects (1997-2010)

● 將軍澳日出康城 Lohas Park	● 薄扶林貝沙灣 Residence Bel-Air
● 奧運海桃灣 Florient Rise	● 澳門君悅灣 The Residencia Macau
● 九龍衛理徑衛理苑 Wylie Court	● 元朗翹翠峰 Emerald Green
● 大圍名城 Festival City	● 大埔道翠峰28 Emerald Twenty Eight
● 澳門青洲社會房屋綜合體 Complexo de Habitacao Social na Ilha Verde	● 將軍澳疊翠軒 The Pinnacle
● 大圍名城 (2期) Festival City (2nd Phase)	● 將軍澳怡心園 Tseung Kwan O Serenity Place
● 東涌藍天海岸 Tung Chung Coastal Skyline	● 鯽魚涌船塢里 Quarry Bay Shipyard Lane
● 尖沙咀擎天半島 Tsim Sha Tsui Sorrento	● 荔枝角昇悅居 Lai Chi Kwok Liberte
● 中環帝后華庭 Central Queen's Terrance	● 土瓜灣傲雲峰 To Kwa Wan Sky Tower
● 屯門景峰豪庭 Tuen Mun Noble Place	● 太古逸華園 Taikoo Valley
● 尖沙咀嘉文花園 Tsim Sha Tsui Carmen's Garden	● 東涌映灣園 Tung Chung Caribbean Coast
● 將軍澳茵怡花園 Tseung Kwan O Verbena Heights	● 東涌東堤灣畔 Tung Chung Crescent
● 土瓜灣嘉朗豪庭 Tokwawan Carlton Court	● 九龍塘畢架山一號 Kowloon Tong Beacon Hill One
● 堅尼地城萬克頓台 Kennedy Town Manhattan City	● 長沙灣泓景臺 Cheung Sha Wan Banyang Garden
● 將軍澳君傲灣 Tseung Kwan O The Grandiose	● 深井碧堤半島一期 Sham Tseng Bellagio Phase I
● 香港逸東酒店 Eaton Hotel Hong Kong	● 紅磡半島豪庭 Hungghom Royal Peninsula
● 將軍澳都會"馬尼" Tseung Kwan O Metro Town	● 尖沙咀港景峰 Tsim Sha Tsui Victoria Tower

- 符合IPX4表示水從任何方向濺向產品時，對其安全性並無不良的影響。
- 安裝方法請參照操作說明書。
- IPX4 stands for ingress protection that water splashing against the product from any direction shall have no harmful effects to its safety.
- Installation method please refer to the operation instruction.



總代理 Sole Agent :

信興電工工程有限公司
SHUN HING ELECTRIC WORKS AND ENGINEERING CO., LTD.

辦公室 Office :

香港九龍尖沙咀東部加連威老道98號
東海商業中心6樓601室
Room 601, East Ocean Centre, 6/F., 98 Granville
Road, Tsimshatsui East, Kowloon, Hong Kong.

電話 Tel : (852) 2861 2767

傳真 Fax : (852) 2865 6706

網址 Website : www.shew.com.hk

電郵 E-mail : shew@shunhinggroup.com

保養及維修 Maintenance and Repair Service :

信興電器服務中心有限公司
SHUN HING ELECTRIC SERVICE CENTRE LTD.

香港新界葵涌葵興街8號信興中心19樓

19th Floor, Shun Hing Centre,
8 Shing Yiu Street, Kwai Chung, N.T., H.K.

電話 Tel : (852) 2406 5666

傳真 Fax : (852) 2408 0316

- Specifications are subject to change without prior notice
- 產品規格如有變更，恕不另行通知。

KDK Company, Division of PES

Head Office: 4017, Takaki-cho, Kasugai, Aichi, Japan
<http://kdk.jp>

CATALOG NO:K-HKVF001D1
Printed in Hong Kong 07.10