

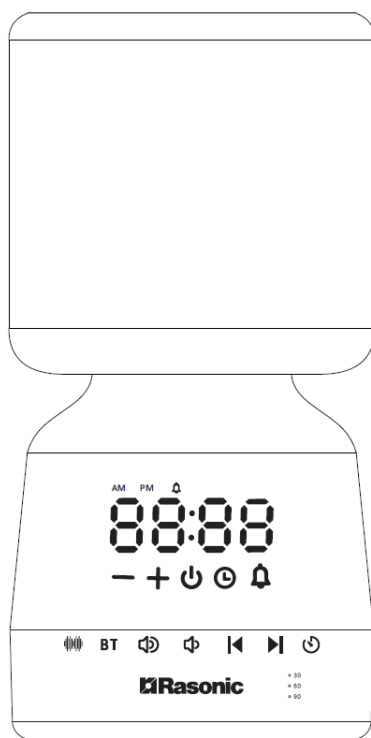

AROMUSE/W
AROMUSE/B
AROMUSE/G

擴香氣氛喇叭燈
Aroma Mood Light Speaker



僅適用於家庭使用
For household use only

使用說明書

OPERATION MANUAL

在使用本產品前，仔細閱讀本說明書，並妥善保存本說明書，以備日後查閱。

Read the operation manual carefully before using and well keep it in a safe place for future reference.

本說明書中的圖示可能與實物有不同的地方，僅供參考。

Some figures in this manual may not match with the actual product, just for reference only.

非常感謝您選購樂信牌擴香氣氛喇叭燈，在使用前詳細閱讀本說明書，並保存以備日後參考。

1.安全注意事項

使用本產品時，必須遵守下列安全預防措施：

1. 為免危險，產品只適用於本說明書所註明的用途。切勿將產品或任何部份在室外使用或作其他用途使用。如錯誤操作，可造成傷害。
2. 切勿同時按下兩個或更多按鈕。
3. 在雷暴天氣或長時間不使用時，須拔掉產品的電源。
4. 切勿擅自改裝產品或使用非生產商提供的零件進行修理，否則可能造成危險及維修保養將無效。
5. 確保使用正確電源。按照說明書指示將產品連接正確電源插頭及電源插座。
6. 本產品不具備防水性，須保持乾爽。切勿把本產品、USB 線或插頭浸入水中；或被水濺濕，以免造成觸電或火災。
7. 本產品的精油擴香機不能倒置。
8. 必須使用植物純精油，精油可以加基礎油進行稀釋。水溶性精油不適用。
9. 產品不應由肢體、感官或精神能力缺憾或缺少使用經驗和知識的人(包括:兒童)使用，除非有負責他們安全的人對他們進行與本產品使用有關的監督或指導。
10. 監督兒童不可將產品當作玩具。將產品及其 USB 線放於兒童不能接觸的地方。
11. 安裝香薰瓶和清潔時，須拔掉電源插頭。
12. 切勿將產品或電池暴露在高溫下。
13. 本產品含有不可充電的電池，這些電池不能充電。切勿使用改造或損壞的電池。注意電池驅動的產品或電池的終端被金屬物體短路的風險。如果產品要長期存放不用，應將電池取出。
14. 電量耗盡的電池應從產品中取出，須用膠帶等纏繞做好絕緣措施後廢棄。
15. 如果電池洩漏並且洩漏物質接觸到皮膚或衣物，須用乾淨的流水徹底沖洗接觸位置。如果接觸到眼睛，須用大量乾淨的流水徹底沖洗並立即尋求醫療救助。
16. 警告:電池須放在兒童觸不到的地方。吞咽電池可導致化學灼傷、軟組織穿孔和死亡。攝入後 2 小時內可能發生嚴重燒傷，立即尋求醫療救助。

2. 配件清單

擴香氣氛喇叭燈 x 1、USB 線 x 1、使用說明書 x 1

4.2 主機

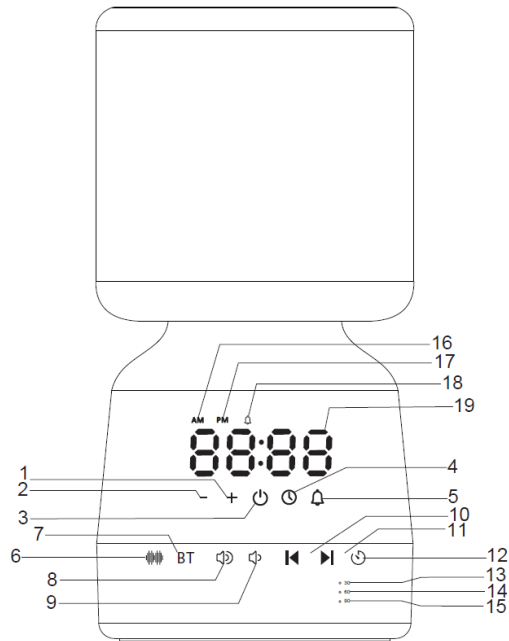

- | | | | |
|----------|----------|--------------|----------|
| 1. 增加鍵 | 6. 白噪音鍵 | 11. 下一首鍵 | 16. 上午圖示 |
| 2. 減少鍵 | 7. 藍牙鍵 | 12. 定時鍵 | 17. 下午圖示 |
| 3. 開/關鍵 | 8. 音量調高鍵 | 13. 30 分鐘指示燈 | 18. 鬧鐘圖示 |
| 4. 時間設定鍵 | 9. 音量減少鍵 | 14. 60 分鐘指示燈 | 19. 顯示屏 |
| 5. 鬧鐘鍵 | 10. 上一首鍵 | 15. 90 分鐘指示燈 | |

5. 操作說明

1. 燈

開/關燈	按 ⏻ 鍵切換燈效及關燈。 白燈 -> 彩燈 -> 關燈
設定燈光	白燈 - 預設亮度為第 3 級，共有 10 級亮度。按+或-鍵調整所需亮度。由於級數比較多，調光時變化細膩，所以每按一次+或-鍵亮度感覺變化不大。長按+或-鍵，可以快速調整燈的亮度。 彩燈 - 預設為自動循環，共有 7 個顏色組合。按+鍵或-鍵可以固定彩燈在選定的顏色組合。如果由固定色轉回自動變色，需要按開/關鍵重新轉為彩燈模式。

產品在同一時間只能運行一種主要功能(藍牙播放、白噪音播放、時鐘設定及鬧鐘設定)，不能同時進行其他功能設置。

2. 藍牙播放

(在藍牙播放時，不能設定時鐘及鬧鐘、切換 12 小時/24 小時時鐘制式及開啓鬧鐘功能等。)

開啟藍牙	長按 BT 鍵 2 秒開啟藍牙，會有提示聲響起。連接藍牙裝置 (AROMUSE)，成功連接及斷開連接均會有提示聲。
關閉藍牙	長按 BT 鍵 2 秒關閉藍牙。
播放/暫停	按 BT 鍵播放或暫停。
上一首歌	按 ◀ 鍵播放上一首歌曲。
下一首歌	按 ▶ 鍵播放下一首歌曲。
設定音量	按 🔊 及 🔇 鍵調整音量大小。

3. 白噪音

(在白噪音播放時，不能設定時鐘及鬧鐘、切換 12 小時/24 小時時鐘制式及開啓鬧鐘功能等。)

開啟/關閉白噪音	按 🎧 鍵開啟和關閉白噪音。
上一首聲音/下一首聲音	按 ◀ 鍵及 ▶ 鍵播放上一首聲音或下一首聲音。(預設 10 種聲音。)
設定音量	按 🔊 及 🔇 鍵調整音量大小。

4. 定時關機

啟動定時	當燈或藍牙/白噪音開啟時，按 ⏰ 鍵啟動定時功能。
設定定時	按 ⏰ 鍵設定定時時間，對應的指示燈會亮起。 30 分鐘 -> 60 分鐘 -> 90 分鐘 -> 關閉。
取消定時	按 ⏰ 鍵取消定時功能。 或者，如果關閉燈或藍牙/白噪音，定時功能會同時被取消。











5. 時鐘

(在設定時鐘時，不能使用藍牙或播放白噪音。)

12 小時 / 24 小時制式 切換	按 ⌚ 鍵可在 12 小時和 24 小時制式之間切換。 如果設定了 12 小時制，則顯示屏上將顯示 AM 或 PM。如果設定為 24 小時制，則顯示屏上不會顯示 AM 或 PM。
設定時鐘	長按 ⌚ 鍵 2 秒。 當小時數字閃爍時，按 +/- 設定小時數字，然後按 ⌚ 鍵確認。 當分鐘數字閃爍時，按 +/- 設定分鐘數字，然後按 ⌚ 鍵確認。 如果設定閒置 30 秒，數字停止閃爍，設定將返回並顯示最後的時鐘設定。

6. 鬧鐘

(在設定鬧鐘時，不能使用藍牙或播放白噪音。)

啟動或取消鬧鐘	當時鐘設定後，按  鍵啟動鬧鐘，對應的圖示將顯示在顯示屏上，鬧鐘時間顯示 3 秒後回到時鐘顯示。再次按  鍵可取消鬧鐘，對應的圖示將不會顯示在顯示屏上。
設定鬧鐘時間、聲音、音量和持續時間	長按  鍵 2 秒直至小時值閃爍，按 +/- 設定小時值，然後按  鍵設定分鐘值，按  鍵確認。 產品會進入鬧鐘聲音設定，按 +/- 設定鬧鐘聲音，共有 10 種聲音可設定。按  鍵確認。 產品會進入鬧鐘音量設定，按 +/- 設定鬧鐘音量，共有 20 級音量可設定。按  鍵確認。 產品會進入鬧鐘提前開燈時間設定，預設鬧鐘提前開燈時間為 10 分鐘。按 +/- 切換鬧鐘提前開燈時間，可設定 5 分鐘->10 分鐘->20 分鐘->30 分鐘->60 分鐘。 按  鍵確認，產品會轉回時鐘顯示。
模擬日出	在設定鬧鐘提前開燈時，燈會在鬧鐘響起前模擬日出逐漸增加其亮度，並在鬧鐘啟動時達到最光亮度。當燈亮度增強時，對應的圖示會出現並在顯示屏上閃爍。 長按  鍵 2 秒可提早關閉燈光。
貪睡模式	鬧鐘響起後，按下任何鍵（  鍵除外）會關閉燈光和鬧鐘，燈光和鬧鐘會在 5 分鐘後重新亮起和響起。
停止鬧鐘	鬧鐘響起後 5 分鐘後會自動停止鬧鐘，同時關閉燈光。或者按  鍵可關閉鬧鐘。

7. 擴香機

安裝擴香機	從燈頂部向上提起擴香機，旋開香薰瓶，加入精油，然後旋緊。將擴香機上的垂直標記與燈頂部的三角形標記▲對齊，然後將其插回燈內。
開啟/關閉擴香機	按 ON/OFF 鍵開啟/關閉擴香機。
設定擴香模式	預設模式為低。按 Mode 鍵切換擴香等級。低輸出 -> 中輸出 -> 高輸出。擴香等級對應的指示燈將會亮起。 低輸出：擴香機工作 10 秒，停止 90 秒。 中輸出：擴香機工作 10 秒，停止 60 秒。 高輸出：擴香機工作 10 秒，停止 30 秒。
設定擴香機時間	預設定時器為 4 小時，但沒有對應的指示燈。按下 Timer 鍵切換定時功能。1h (1 小時) -> 2h (2 小時) -> 3h (3 小時) -> 4 小時。定時器對應的指示燈(4 小時除外)將會亮起。

清潔擴香機	當長期不使用精油擴香機後再次使用時，或者更換精油種類時，需按以下步驟清潔： 第一步：在空的精油瓶中倒入約 10 毫升 75%濃度的酒精。 第二步：將擴香機放回燈內，開啟高輸出，於噴霧出現 20 分鐘後關掉擴香機。 第三步：將精油瓶剩餘酒精倒掉，重新裝入精油正常使用。
-------	--

8. 顯示屏亮度

顯示屏亮度會根據環境亮度自動調整。環境越亮，顯示屏越亮，環境越暗，顯示屏會變暗。

6. 產品規格

額定輸入	Type-C 9 伏特，2.77 安培
額定輸出	Type-C 5 伏特，1 安培，5 瓦
額定功率	25 瓦
20 毫升精油使用時間	低輸出約 50 日 / 中輸出約 30 日 / 高輸出約 20 日

7. 特別聲明

1. 此說明書上所有內容經過核對，如有任何印刷錯誤或內容上的誤解，本公司將保留解釋權。
2. 本產品若有技術改進，會編進新版說明書中，恕不另行通知；產品外觀及規格以廠方生產資料為準。
3. 此說明書的電子副本可透過電子郵件發送致客戶。如有需要，請致電信興電工工程有限公司：2861 2767。

8. 售後服務

信興電工工程有限公司(“本公司”)授權信興電器服務中心有限公司(“服務中心”)提供 1 年保修服務並由發票/換購收據上的日期起計。服務中心保留所有更改保修條款的權利，恕不另行通知，有關保修條款詳情，可參閱本公司網站。

Thank you for choosing Rasonic Aroma Mood Light Speaker. Read the operation manual carefully before using and keep it for your future reference.

1. Important Safeguards

When using the appliance, please follow the below safety precautions:

1. To avoid danger, use the appliance only as described in the operation manual. Do not use it or any part outdoors or out of the intended purpose. Misuse can cause potential injury.
2. Do not press two or more buttons at the same time.
3. Unplug the appliance during a thunderstorm or when not use for a long time.
4. Do not attempt to modify the appliance by yourself or repair with any unauthorized parts, otherwise it will cause hazards and the warranty becomes invalid.
5. Make sure you are using the correct power source. Connect the appliance to the correct power plug and wall outlet according to the instructions in the manual.
6. The appliance is not waterproof and must be kept dry. Never immerse the appliance, USB cable or plug in water or let them wet, it can cause electric shock or fire.
7. The aroma diffuser cannot be turned upside down.
8. Pure essential oils from plants must be used, and the essential oils can be diluted with carrier oil. Water-soluble essential oils cannot be used.
9. The appliance is not intended for use by persons (including children) with reduced physical, sensory or mental capabilities, or lack of experience and knowledge, unless they have been given supervision or instruction concerning use of the appliance by a person responsible for their safety.
10. Children should be supervised not to play with the appliance. Keep the appliance and its USB cable out of reach of children.
11. Unplug the appliance during installing the aroma bottle and cleaning.
12. Do not expose the appliance or battery to excessive temperatures.
13. The appliance contains non-rechargeable battery; the battery is not to be recharged. Do not use modified or damaged battery. Be aware of the risk of terminals of battery-operated appliance or battery being short-circuited by metal object. If the appliance is to be stored unused for a long period, the battery should be removed.
14. Exhausted battery is to be removed from the appliance. Wind it with adhesive tape and keep it properly insulated before disposal of the battery.
15. If the battery leaks and the leaked substance comes into contact with the skin or clothing, rinse the contact area thoroughly with clean running water. If in contact with eyes, rinse thoroughly with plenty of clean running water and seek medical attention immediately.
16. **WARNING:** Keep the battery out of reach of children. Swallowing can lead to chemical burns, perforation of soft tissue, and death. Severe burns can occur within 2 hours of ingestion. Seek medical attention immediately.

2. Package Details

Aroma Mood Light Speaker x 1, USB Cable x 1, Operation Manual x 1

3. Setting Up

1. The appliance requires a main supply of 25W transformer. Using a transformer lower than 25W, some functions of the appliance may not able to work properly.
2. Connect one end of the USB cable to the power input port (ii) of the appliance, the other end to a 25W transformer, and then plug it into the wall socket.
3. When the appliance is powered on, user can connect one end of the USB cable to the power output port (i) of the appliance, the other end to other external devices offering 1A power source for their use.

i. Output DC 5V, 1A

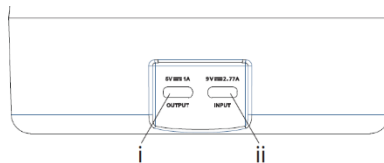

ii. Input DC 9V, 2.77A

4. A battery is inserted at the bottom of the appliance to provide back-up power source. Take out the battery isolator stripe from the battery compartment after time is set with socket power. Battery is only to record the clock and alarm setting and ensure their operation unaffected by power outages. When the power is restored, the clock and alarm do not need to be reset. If it is not connected to a proper power source, the clock time will not be displayed and the alarm will not sound. The appliance cannot be operated when no connection with 25W or higher transformer.

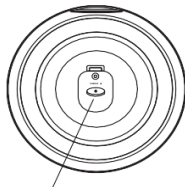

Backup battery: 1 X CR2032

5. For the first time using, user must set the clock before using other functions.

4. Product Description

4.1 Diffuser

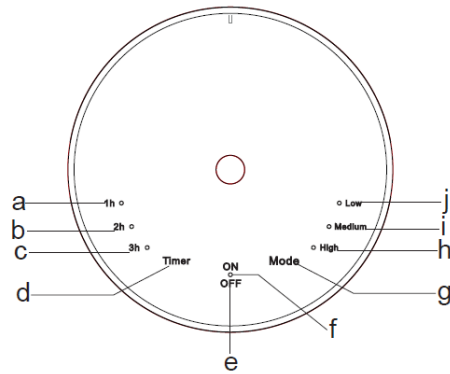

- | | | |
|--------------------------|-------------------------|---------------------|
| a. 1 hour indicator | e. ON/OFF button | i. Medium indicator |
| b. 2 hours indicator | f. ON/OFF indicator | j. Low indicator |
| c. 3 hours indicator | g. Diffuser mode button | |
| d. Diffuser timer button | h. High indicator | |

4.2 Main unit

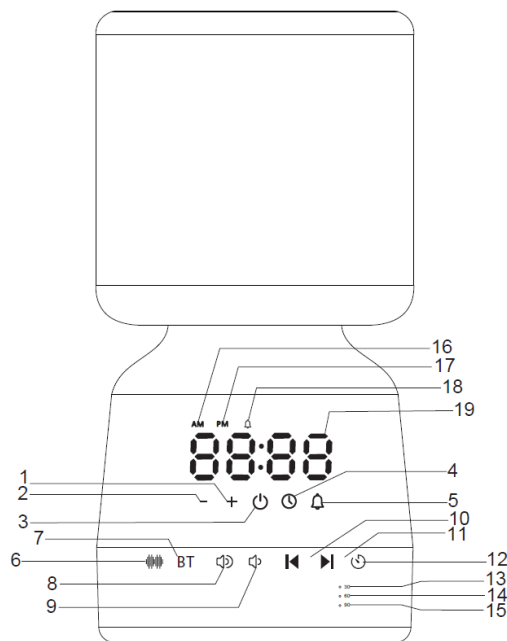

- | | | | |
|------------------------|-----------------------|----------------------|----------------|
| 1. Increase button | 6. White noise button | 11. Next button | 16. AM icon |
| 2. Decrease button | 7. Bluetooth button | 12. Timer button | 17. PM icon |
| 3. On / Off button | 8. Volume up button | 13. 30mins indicator | 18. Alarm icon |
| 4. Time setting button | 9. Volume down button | 14. 60mins indicator | 19. Display |
| 5. Alarm button | 10. Previous button | 15. 90mins indicator | |





5. Operation Instructions

1. Light





Turn on/off the light	Press  button to turn on different light and turn off the light. White light -> Mood light -> Off.
Set the light level	White light - Default brightness level is 3, there are 10 levels of brightness. Press +/- button to adjust the brightness. Since there are many dimming levels and the changes are delicate, the brightness does not change much every time you press the + or - button. Long press +/- button can adjust the brightness quickly. Mood Light – Default setting is automatic loop and there are 7 sets of color combination. Press + or - button to fix the mood light in the selected color combination. If switching from fixed color light mode to automatic loop of color, press the on/off button to return to mood light mode.

The appliance can only operate a main function at a time (bluetooth speaker, white noise playback, clock setting and alarm setting), other function settings cannot be performed at the same time.

2. Bluetooth speaker (When turning on the bluetooth speaker, user cannot set the clock and alarm, switch between 12-hour and 24-hour clock formats, or turn on the alarm function.)



Turn on the bluetooth	Long press BT button for 2 seconds to turn on the bluetooth, the remind music will sound, connecting the bluetooth device (AROMUSE), the remind music will sound if connected and disconnected the bluetooth.
Turn off the bluetooth	Long press BT button for 2 seconds
Play/pause	Press BT button to play or pause it.
Previous song	Press  button to play previous song.
Next song	Press  button to play next song.
Set the volume	Press  and  button to adjust the volume.

3. White noise (When turning on white noise, user cannot set the clock and alarm, switch between 12-hour and 24-hour clock formats, or turn on the alarm function.)





Turn on/off the white noise	Press  button to turn on and off the white noise.
Previous/next sound track	Press  and  button to play previous or next sound track. (There are 10 preset sound track.)
Set the volume	Press  and  button to adjust the volume.

Shew0000

4. Timer









Activate the timer	When the light or bluebooth/white noise is on, press  button to activate timer.
Set the timer	Press  button to switch on the timer and the corresponding indicator will light up. 30 mins -> 60 mins -> 90 mins -> Off.
Deactivate the timer	Press  button to deactivate timer. Or the timer will be deactivated if turn off the light or bluebooth/white noise.



5. Clock (When setting the clock, user cannot turn on the bluetooth speaker and white noise.)

Switch 12H/24H	Press  button to switch between 12-hour and 24-hour clock set. AM or PM will show in the display if 12-hour clock set. AM or PM will not show in the display under 24-hour clock set.
Set the clock time	Long press  button for 2 seconds. When the hour digit flashes, press + / - to set the hour digit, then press  to confirm. When the minute digit flashes, press + / - to set the minute digit, then press  to confirm. If the setting is left idle for 30 seconds, the digit stop flashing, the setting will be cancelled and show the last clock setting.

6. Alarm

(When setting the alarm, user cannot turn on the bluetooth speaker and white noise.)

Activate or deactivate the alarm	When the clock set, press  to activate the alarm, the corresponding icon will show in the display. The alarm time will show for 3 seconds and resume to show the clock time. Press  again to deactivate the alarm, the corresponding icon will not show in the display.
Set the alarm time, sound, volume and duration	Long press  button for 2 seconds until the hour digit flashing, press + / - to set the hour digit, then press  to set the minute digit , press  to confirm. It will switch to alarm sound setting, press + / - to set the alarm sound, 10 sounds can be set. Press  to confirm. It will switch to alarm volume setting, press + / - to set the alarm volume, 20 volume levels can be set. Press  to confirm. It will switch to set the wake up light timer, the default wake up light timer is 10 mins before the alarm time. Press + / - to set the wake up light timer, 5 mins -> 10 mins -> 20 mins -> 30 mins -> 60 mins can be set. Press  to confirm and the clock time will be shown again.

Sunrise simulation	When the wake up light timer set, the light can simulate sunrise to gradually increase its intensity and reaches the highest intensity at the alarm time. The corresponding icon appears and flashes on the display during the lamp is increasing its intensity. Long press  button for 2 seconds to turn off the light.
Snooze	Once the alarm rings, press any button (except  button) to turn off the lamp and the alarm. The lamp and alarm will turn on again after 5 minutes.
Cancel the alarm	The alarm will be stopped after 5 mins and the light will be off. Or press  button to turn off the alarm.

7. Diffuser

Set up the diffuser	Lift up the diffuser from the top of the lamp, unscrew the aroma bottle, add an essential oil, and tighten it. Align the vertical mark on the diffuser with the triangle mark  on the top of the lamp and insert it back.
Turn on/off the diffuser	Press ON/OFF button to turn on and off the diffuser.
Set the atomization level	Default mode is low. Press Mode button to switch the atomization level. Low -> Medium-> High. The atomization indicator corresponding to the intensity will light up. Low mode: Diffuser works for 10 sec and stop for 90 sec. Medium mode: Diffuser works for 10 sec and stop for 60 sec. High mode: Diffuser works for 10 sec and stop for 30 sec.
Set the diffuser timer	Default timer is 4 hours, but without corresponding indicator. Press timer button to switch the timer. 1h -> 2h -> 3h -> 4h. The indicator corresponding to the timer will light up, except the 4h.
Clean the diffuser timer	When using the aroma diffuser again after not using it for a long time, or when changing the type of essential oil, it must be cleaned according to the following steps: Step 1: Pour about 10 ml of alcohol with a purity of 75% into an empty essential oil bottle. Step 2: Put the aroma diffuser back into the appliance, turn on the high mode, and turn off the aroma diffuser 20 minutes after the atomization appears. Step 3: Pour away the remaining alcohol from the essential oil bottle and fill it with essential oil for normal use.

8. Brightness of display

The brightness of display will be automatically adjusted according to the ambient brightness. The brighter the environment, the brighter the display will be; and the darker the environment, the display will darken accordingly.

6. Specification

Rated input	Type-C 9V, 2.77A
Rated output	Type-C 5V, 1A, 5W
Power consumption	25W
Usage time for 20ml essential oil	Approx. 50 days in low mode / Approx. 30 days in medium mode / Approx. 20 days in high mode

7. Special Avowal

1. The content in the operation manual has been checked. Our company reserves the hermeneutic power to any printing errors or misunderstanding on the content.
2. If there are technical improvements on the appliance, the operation manual will be updated in new version without prior notice. The product appearance and specification are subject to the manufacturer information.
3. The e-copy of operation manual can be sent by email on request. For enquiry, please call Shun Hing Electric Works and Engineering Co., Ltd. at 2861 2767.

8. After Sales Service

Shun Hing Electric Works & Engineering Co., Ltd. ("The Company") authorizes Shun Hing Electric Service Centre Ltd. ("SHESC") to offer 1 year warranty service to the product commencing from the date of purchase invoice or redemption voucher. SHESC reserves the rights to change the warranty terms without prior notice. For details of warranty terms, you can refer to our website.



SHUN HING GROUP
信興集團
SINCE 1953

Rasonic 樂信牌

信興電工工程有限公司

SHUN HING ELECTRIC WORKS AND ENGINEERING CO., LTD.

辦公室：香港九龍尖沙咀東部麼地道 67 號半島中心 9 樓

電話：2861 2767

圖文傳真：2865 6706

網址：<http://www.rasonic.hk>

電郵：shew@shunhinggroup.com

Office: 9/F, Peninsula Centre, 67 Mody Road, Tsimshatsui East, Kowloon, Hong Kong

Tel: 2861 2767

Fax: 2865 6706

Website: <http://www.rasonic.hk>

E-mail: shew@shunhinggroup.com

保養及維修 Maintenance and Repair Service:

信興電器服務中心有限公司

SHUN HING ELECTRIC SERVICE CENTRE LTD.

香港新界葵涌勝耀街 2 號信興中心 11 樓

電話：2406 5666

圖文傳真：2408 0316

網址：<https://www.shunhing-service.com/zh>

11/F, Shun Hing Centre, 2 Shing Yiu Street, Kwai Chung, N.T. HK

Tel: 2406 5666

Fax: 2408 0316

Website: <https://www.shunhing-service.com/en>

客戶服務中心：

香港新界葵涌勝耀街2號信興中心1樓

九龍尖沙咀東部麼地道67號半島中心B座9樓

香港天后琉璃街7號柏景中心22樓

澳門慕拉士大馬路193-199號南嶺工業大廈5樓I座

Customer Service Centre

1/F, Shun Hing Centre, 2 Shing Yiu Street, Kwai Chung, N.T.

9/F., Block B, Peninsula Centre, 67 Mody Road, Tsim Sha Tsui East, Kowloon

22/F, Parkview Centre, 7 Lau Li Street, Tin Hau, Hong Kong

Avenida de Venceslau de Morais, No. 193-199, 5 andar - I, Edf. Industrial Nam Leng, Macau

有關最新之香港及澳門客戶服務中心資料，請參閱信興服務中心網址：<https://www.shunhing-service.com/zh>

For the latest information of Hong Kong and Macau service centre, please visit: <https://www.shunhing-service.com/en>

RAM-0125