



R410A 變頻式分體冷氣機

使用說明書及 安裝說明書

室內機型號:

RS-S9KI

RS-S12KI

RS-S18KI

室外機型號:

RU-S9KI

RU-S12KI

RU-S18KI

重要需知:



安裝或操作您的新冷氣機之前請詳閱本說明書。
務必妥善保管本說明書以利日後參考。

目錄

安全注意事項	1
使用說明書	
產品規格與功能	5
1.室內機顯示板介紹.....	5
2.冷氣機工作溫度範圍.....	6
3.其他功能.....	7
4.氣流設定角度.....	8
5.手動操作 (無遙控器).....	8
保養與維護	9
故障排除	11

安裝說明書



配件.....	15
安裝概要-室內機.....	16
冷氣機各部件.....	17
室內機安裝.....	18
1.選擇安裝位置.....	18
2.從機器上取出固定板.....	18
3.於牆上鑽孔以連接銅管.....	19
4.準備雪種管.....	20
5.連接排水軟管.....	20
6.連接信號線.....	21
7.包裝和電纜.....	22
8.安裝室內機.....	23
室外機安裝.....	24
1.選擇安裝位置.....	24
2.安裝排水接頭.....	25
3.固定室外機.....	25
4.連接信號線與電源線.....	27
雪種管路連接.....	28
A.管路長度相關說明.....	28
B.連接指示-雪種管.....	28
1.切割雪種管.....	28
2.去除毛刺.....	28
3.輸送管末端擴口.....	28
4.連接管道.....	29
抽真空.....	30
1.抽真空指示.....	31
2.關於雪種相關說明.....	32
電力和氣體洩漏檢查.....	33
測試運行.....	34

安全注意事項

安裝前請詳閱安全注意事項

因為忽略使用說明中之指示而造成安裝不當會造成嚴重的損失或人員受傷。

潛在損害或人員受傷的嚴重性經分類為警告或小心。

 警告	此符號表示若忽略使用說明中之指示可能造成人員重傷或死亡。
 小心	此符號表示若忽略使用說明中之指示可能造成人員中度的傷害或是您的設備或資產有中度的損失。

警告

若在安全的方式且了解相關風險下，經他人監督或是提供設備使用之相關指示時，則此設備可由八歲及以上之孩童以及肢體、感官或心智能力有所減損者或是缺乏經驗與知識者使用。兒童不得使用此設備做玩樂用途。無監督下，不得由幼童進行清潔或是用戶的維護作業。

產品使用上的警告

安裝警告

若出現異常狀況(像是燒焦味)，請立即關閉設備並拔掉插頭。請與您的經銷商接洽尋求指示以避免觸電、失火或是人員受傷。

請勿將手指、棍棒或其他物體插入進氣口或是出風口中。這樣可能會造成人員受傷，因為風扇可能正以高速旋轉。

請勿在設備附近使用易燃的噴灑液，像是髮膠、亮光漆或是油漆。這樣可能會造成火災或是起火的風險。

請勿在可燃氣體附近或是周遭操作冷氣機。排放的氣體可能會在裝置周圍集中而造成爆炸情形。

請勿在潮濕的房間內操作冷氣機(例如:浴室或洗衣間)。這樣可能會造成觸電並造成產品劣化。

請勿長時間讓您的身體直接暴露在冷空氣中。

請勿讓孩子們玩冷氣機，必須在冷氣機周圍對兒童進行監督。

- 如果將空調與燃燒器或其他加熱設備一起使用，請對房間進行徹底通風以防止缺氧。
- 在某些功能環境中，例如廚房，服務器機房等，強烈建議使用專門設計的冷氣機。

清潔與維護警告

清潔之前請關閉設備並拔下插頭。若不遵守此指示會造成觸電的情形。

請勿使用過量清水清潔冷氣機。

請勿使用易燃的清潔劑清潔冷氣機。易燃的清潔劑會引起火災或設備毀壞。

警告

若您預計長期不使用冷氣機，請關閉設備並拔下插頭。

暴風雨期間請關閉設備並拔下插頭。

請確認凝結的水氣會被排出而不致阻礙設備運作。

請勿於雙手潮濕時操作冷氣機。這樣可能會造成觸電的情形。

請勿於設計用途以外之處使用設備。

請勿於室外機上攀爬或是放置物品。

請勿於房門或視窗戶開啟時長時間運作冷氣機，也不要濕度相當高時運作冷氣機。

電器安全警告

- 僅可使用指定的電源線。若電源線受損，則必須請製造商或是認可之服務代理進行更換。
- 請保持電源插頭的潔淨。請將插頭上或周遭累積的任何灰塵或污垢清除。骯髒的插頭會造成起火或是觸電危險。
- **請勿**將電源線從設備上扯下。請穩固捏住插頭然後再從插座上拔下。直接扯下電源線會造成電源線受損，此情形會導致起火或是觸電危險。
- **請勿**使用延長線、以手動方式延長電源線、或是在相同插座上同時連接冷氣機與其他設備。電線接觸不良、絕緣不良以及電壓不足會引起火災。
- **請勿**與其他電器共用電源插座。電源不正確或不足會引起火災或電擊。
- 產品在安裝時必須正確接地，否則可能會導致觸電。
- 對於所有電氣工作，請遵循所有本地和國家/地區佈線標準，規定和安裝手冊。牢固連接電纜，並牢固地夾緊電纜，以防止外力損壞端子。電氣連接不當會導致過熱並引起火災，並可能引起電擊。所有電氣連接必需根據室內和室外機面板上的電氣連接圖進行。
- 必須正確佈置所有接線，以確保控制板蓋可以正確關閉。如果未正確關閉控制板蓋，則可能導致腐蝕並導致端子上的連接點變熱，起火或引起觸電。
- 如果將電源連接到固定佈線，則是一種全極斷開裝置，其所有極之間的間隙至少為3mm，並且洩漏電流可能超過10mA，剩餘電流裝置（RCD）的額定剩餘工作電流不超過30mA，並且必須按照接線規則將斷開連接納入固定佈線。

注意保險絲規格

冷氣機的電路板（PCB）設計有保險絲，以提供過流保護。

保險絲的規格印在電路板上，例如：

T3.15AL / 250VAC, T5AL / 250VAC, T3.15A / 250VAC, T5A / 250VAC, T20A / 250VAC, T30A / 250VAC等等

注意：對於使用R32或R290製冷劑的設備，只能使用防爆陶瓷保險絲。

產品安裝警告

- 1.
2. 必須按照安裝說明進行安裝。安裝不當會導致漏水，觸電或火災。
3. 請與授權的維修技術人員聯繫以修理或維護本機。本設備應按照當地接線規定進行安裝。
4. 僅使用隨附的附件，零件和指定的零件進行安裝。使用非標準零件可能會導致漏水，觸電，火災，並可能導致設備故障，並令保修失效。
5. 將設備安裝在可以支撐設備重量的牢固位置。如果所選位置不能支撐設備的重量，或者安裝不正確，則設備可能掉落並造成嚴重的人身傷害和損壞。
6. 按照本手冊中的說明安裝排水管道。排水不當可能會損壞您的房屋和財產。
7. 對於帶有輔助電加熱器的設備，**請勿**將其安裝在距離任何可燃材料1米（3英尺）的範圍內。
8. **請勿**將本機安裝在易燃氣體洩漏的地方。如果可燃氣體積聚在設備周圍，則可能引起火災。
9. 完成所有工作之前，請勿開啟電源。
10. 在移動或重新安置冷氣機時，請諮詢合資格的維修技術人員以斷開和重新安裝冷氣機。
11. 如何安裝設備，請閱讀“室內機安裝”和“室外機安裝”部分中的詳細信息。

關於氟化氣體的注意事項（不適用於使用R290製冷劑的裝置）

1. 本冷氣裝置包含氟化溫室氣體。有關氣體類型和數量的具體信息，請參閱設備本身或設備上的相關標籤，或者室外機包裝中的“使用說明書”。
2. 本設備的安裝，維護，保養和維修必須由經過認可的技術人員進行。
3. 產品的卸載和回收必須由認可的技術人員進行。
4. 對於包含的氟化溫室氣體的數量等於或大於5噸二氧化碳當量，但小於50噸二氧化碳當量的設備，如果系統安裝了檢漏系統，則24個月必須至少檢查一次洩漏。
5. 檢查設備是否洩漏時，強烈建議正確保存所有檢查記錄。



2018 年12 月31日起，被棄置受管制電器處置管制、進出口管制及堆填區棄置禁令正式實施。任何人儲存、處理、再加工或循環再造被棄置受管制電器，均須取得廢物處置牌照；輸入及輸出被棄置受管制電器均須領有許可證。堆填區及其他指定廢物處置設施（例如廢物轉運站）則不會再接收和處置被棄置受管制電器。

產品規格與功能

室內機顯示板介紹

注意：不同的型號有不同的前面板和顯示窗口。並非以下描述的所有顯示代碼都適用於您購買的冷氣機。請檢查您購買的設備的室內展示窗口。

本手冊中的插圖用於說明目的。您的室內機的實際形狀可能略有不同。

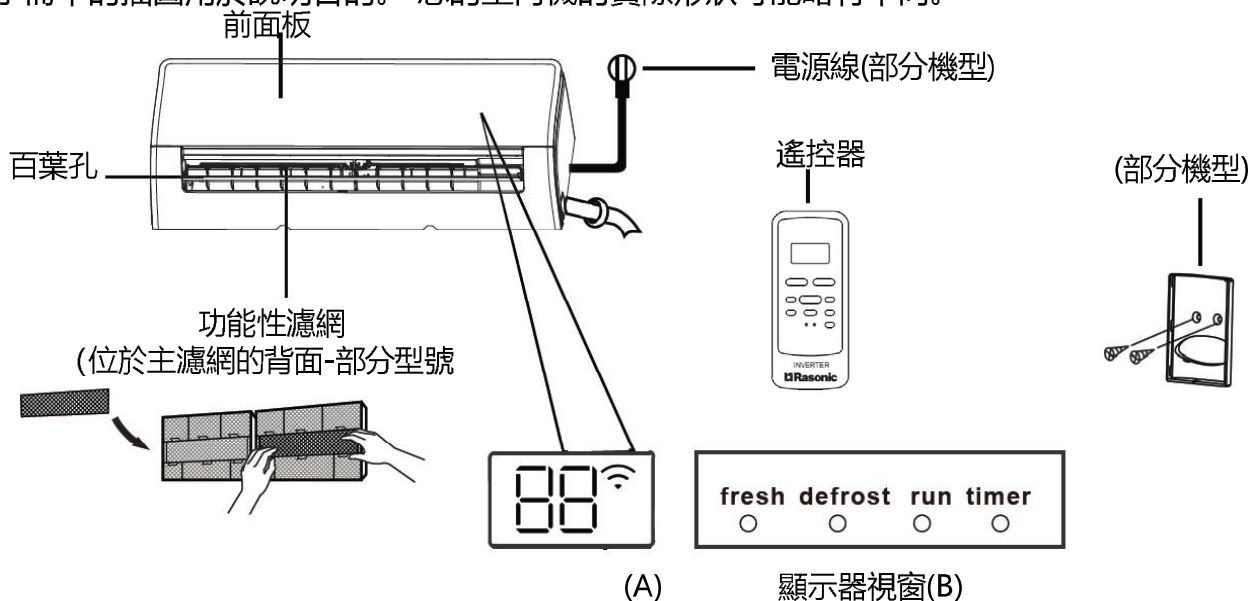

" fresh " 啟用新鮮風功能時 (部分機型)。

" defrost " 啟用除霜功能時。

" run " 當本機開啟時。

" timer " 設置定時器時。

"  " 啟用無線遙控功能時 (不適用)。

" 88 " 顯示溫度，操作功能和錯誤代碼：

"  " 在以下情況下保持3秒鐘：

- 設置定時開(在關機狀態下，則設置定時開時 ""保持打開)
- 開啟清新、風扇擺動、強冷、節能或靜音功能時

"  " 在下列情形中，連續三秒：

- 設定計時器 (定時關機)
- 關閉清新、風扇擺動、強冷、節能或靜音功能時

"  " 冷氣機執行 "除霜" 動作

"  " 表示冷氣機開啟主動清潔功能

代碼信息

冷氣機工作溫度範圍

在以下溫度範圍以外使用冷氣機時，某些安全保護功能可能會激活並導致本機禁用。

	冷氣模式	抽濕模式	對於帶有輔助電加熱器的戶外設備 當室外溫度低於0°C (32°F)時，我們 強烈建議讓設備插頭保持插上的狀態 以確保順暢的持續效能。
室內溫度	16°C - 32°C (60°F - 90°F)	10°C - 32°C (50°F - 90°F)	
室外溫度	0°C - 50°C (32°F - 122°F)	0°C - 50°C (32°F - 122°F)	

注意：房間的相對濕度應小於80%為佳。如果冷氣的運行超出此數值，則冷氣機表面可能會凝結水。請將垂直氣流百葉窗設置為最大角度（垂直於地板），然後設置為高風速模式。

為了進一步讓您的冷氣效能最佳化，請執行下列動作：

- 保持門窗關閉。
- 使用定時開機(TIMER ON) 以及定時關機(TIMER OFF)功能以節約能源的使用。
- 請勿阻礙進氣口或出風口。
- 定期檢查與清潔濾網。

其他功能

自動重新啟動

設備失去電力，其將於電力恢復時自動採取先前的設定重新啟動。

防霉(不適用)

在冷氣模式、自動(冷氣)或是抽濕模式中關閉設備時，冷氣機將會以相當低的電力繼續運轉好讓凝結水乾燥並避免霉菌的生成。

無線遙控 (不適用)

您可以使用手機或是無線連線控制冷氣機。

至於USB裝置的存取、更換、維護作業，則必須由專業人士執行。

送風葉角度記憶

啟動設備時，送風葉將會自動重返先前的角度。主

主動清潔功能

--主動清潔技術通過自動凍結然後迅速解凍而將附在熱交換器上的灰塵，霉菌和油脂這些可能會引起氣味的物質沖走。清潔期間會聽到“pi-pi”的聲音。

--主動清潔作用於產生更多的冷凝水以提高清潔效果，並且冷空氣會吹出。清潔後，內部風輪將繼續用熱空氣吹乾蒸發器，從而保持內部清潔。

--打開此功能後，室內機顯示窗口將顯示“CL”，在20至130分鐘後，室內機將關閉。自動取消主動清潔功能。

--對於某些設備，系統將啟動高溫清潔過程中，出風口溫度很高。請遠離它。這將導致室溫升高。

除霜功能

冷氣機監測到冷凝器結霜的時候會自動啟動除霜功能，中途不能停止直至除霜完成。

微風 (不適用)

此功能可避免氣流直接吹向身體，讓您沉迷於絲般的涼爽。

雪種外洩偵測

當室內機偵測到雪種外洩時，設備會自動顯示出“EL0C”或者閃LED燈。

睡眠運行模式

睡眠功能用於在您睡眠時降低能源的使用(且無需相同的溫度設定以保持舒適)。此功能僅可透過遙控器啟動。

當您準備就寢時，請按壓睡眠(SLEEP)按鈕。

在冷氣模式中，設備會於一小時後增加溫度1°C (2°F)，並將於再隔一小時後又增加1°C (2°F)。使用暖氣模式時，設備會於一小時後降低溫度1°C (2°F)，並將於再隔一小時後又降低1°C (2°F)。其將維持在新溫度上持續運行。(暖氣模式不適用於淨冷型號)

睡眠功能將在8小時後停止，並且系統將在最終情況下繼續運行。

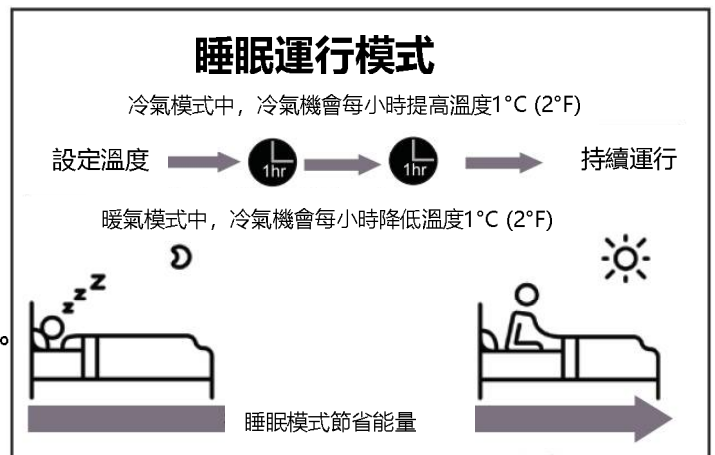

氣流設定角度

設定氣流的垂直角度

設備啟動時，請使用風扇擺動(SWING)/直吹(DIRECT)按鈕來設定氣流的方向(垂直角度)。

詳情請參閱遙控器手冊。

送風葉角度的注意事項

當使用冷氣模式 (COOL) 或抽濕模式 (DRY) 時，請勿將送風葉長時間垂直放置。這會導致水在送風葉板上凝結，這會掉落在地板或家具上。

當使用冷氣模式 (COOL) 或暖氣模式(HEAT)時(暖氣模式不適用於淨冷型號)，由於氣流受限制，將送風葉設置得太垂直可能會降低本機的性能。

設定氣流的水平角度

必須手動設定氣流的水平角度。握住撥桿(請參考圖B)然後手動調整到您想要的位置。

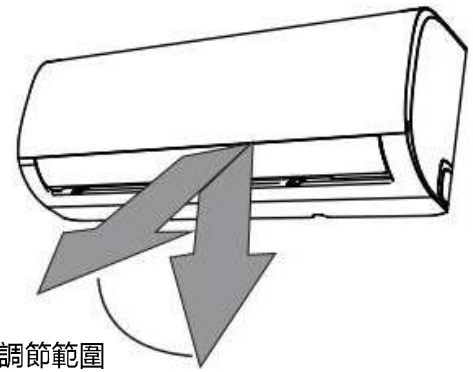

調節範圍

注意：請勿用手移動送風葉。這將導致送風葉不同步。如果發生這種情況，請關閉設備電源並拔下電源插頭幾秒鐘，然後重新啟動設備。這將重置送風葉角度。

圖 A

手動操作(無遙控器)

注意：手動按鈕僅用於測試目的和緊急操作。除非遙控器丟失並且絕對必要，否則請不要使用此功能。要恢復正常操作，請使用遙控器激活本機。手動操作前必須關閉設備。

若想以手動方式操作您的設備：

- 1.請打開室內機的前面板。
- 2.請找出位於設備右邊的手動控制按鈕。
- 3.請按壓手動控制按鈕一次以啟動強制自動(FORCED AUTO)模式。
- 4.請再次按壓手動控制按鈕以啟動強制散熱(FORCED COOLING)模式。
- 5.請按壓手動控制按鈕 第三次即可將設備關閉。
- 6.請關閉前面板。

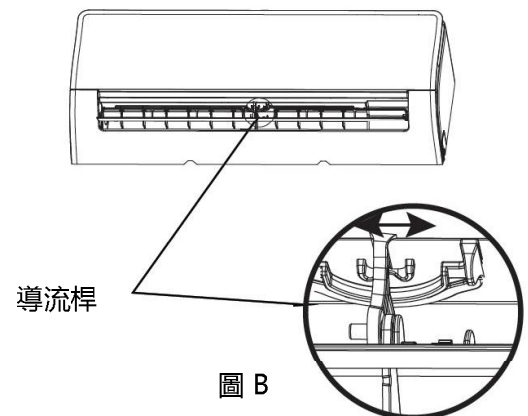

導流桿

圖 B

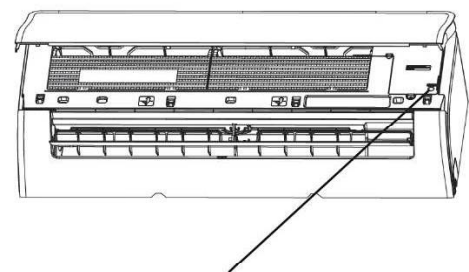

注意：請勿將您的手指放入或接近風箱以及設備的吸氣側中。設備內部的高速風扇可能會造成受傷。

保養與維護

清潔您的室內機



清潔或維護之前

進行清潔或維護之前，務必先關閉冷氣機並切斷電源供應。



小心

僅可使用柔軟的乾布將設備擦乾淨。若設備相當骯髒，則用抹布浸泡於溫水中再將設備擦乾淨。

- 請勿使用化學品或是經化學處理過的布料清潔設備
- 請勿使用苯、油漆稀釋劑、拋光粉或其他溶劑清潔設備。這些物質會造成塑膠表面出現裂縫或變型
- 請勿使用溫度高於40°C (104°F)的清水清潔前面板。這樣會造成面板變形或是褪色。

清潔濾網

冷氣機濾網若是堵塞就會降低您的設備效率，並且也對您的健康有害。務必每隔兩周清潔您的濾網一次。

1. 抬起室內機的前面板。
2. 抓住濾網端上的調整片，向上舉、然後朝向您自身拉動。
3. 現在請拉出濾網。
4. 若您的濾網含有小型的空氣清新濾網，請從較大型的濾網上鬆開。請用手持吸塵器清潔此空氣清新濾網。
5. 使用溫的肥皂水清潔大型濾網。務必使用溫和的清潔劑。
6. 使用清水沖洗濾網，然後甩乾多餘水分。
7. 在陰涼、乾燥處乾燥，並避免暴露於日光直射處。
8. 乾燥後，請重新裝上空氣清新濾網到大型濾網上，然後滑回室內機中。
9. 請閤上室內機的前面板。

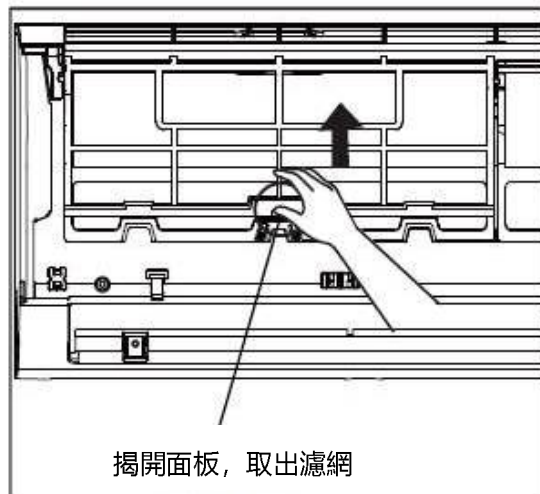

揭開面板，取出濾網

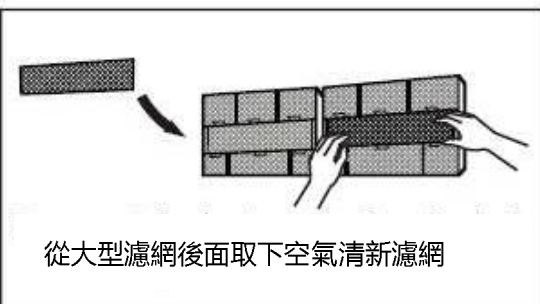
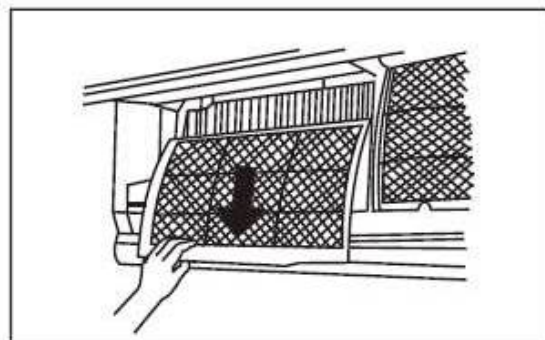

從大型濾網後面取下空氣清新濾網



小心

關閉冷氣機電源後，請勿立即觸摸空氣清新(等離子)過濾網，至少等10分鐘。

小心

- 更換濾網或清潔之前，請關閉設備並切斷電源供應。
- 取下濾網時，請勿觸摸到設備上的金屬零件。鋒利的金屬邊緣會割傷您。
- 請勿用水清潔室內機內部。這樣會破壞絕緣並造成觸電的情形。
- 乾燥濾網時，請勿讓濾網暴露在陽光直射下。這會讓濾網收縮變形。

空氣過濾器清潔提醒 (可選)

• 使用240小時後，室內機的顯示窗口將閃爍“CL”。這是清潔過濾器的提醒。15秒後，本機將恢復到之前的顯示

若想重設提醒，請按壓遙控器上的LED按鈕四次，或是按壓 手動控制 按鈕三次。若您沒有重設提醒，則“CL”指示燈會於您重新啟動設備時再次閃爍。

濾網更換提醒

在 2,880小時的使用後，室內機上的顯示器視窗會閃爍“nF”字樣。這是提醒您更換濾網。十五秒後，設備會還原到先前的顯示。

若想重設提醒，請按壓LED按鈕：

請按壓遙控器上的LED按鈕四次，或是按壓手動控制按鈕三次。若您沒有重設提醒，則重新啟動本機時，指示燈“nF”將再次閃爍。

小心

- 室外機的任何維護與清潔都應由授權經銷商或有執照的服務供應商執行。
- 所有的設備維修都應由授權經銷商或有執照的服務供應商執行。

維護—長期不使用

如果您打算長時間不使用冷氣機，請執行以下操作：

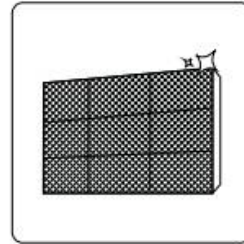

清潔所有



開啟風扇(FAN)功能直到冷氣機完全乾燥



關閉冷氣機，並斷開電源

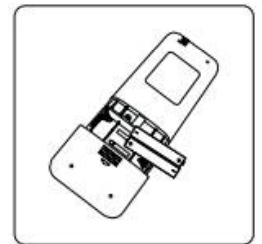

取出遙控器的電池

維護—季前檢查

長期未使用後，或是在頻繁使用的期間來臨之前，請執行下列動作：



檢查是否有電線受損

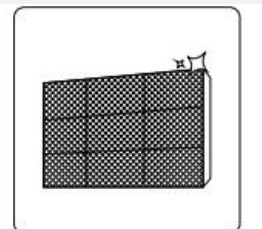

清潔所有濾網

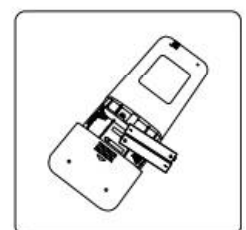

安裝遙控器的電池



請確認沒有任何東西堵塞住所有進氣口和出風口

故障排除

安全注意事項

若出現下列任何一狀況，請立即關閉您的設備！

- 電源線受損或是異常溫熱
- 聞到燒焦氣味
- 設備發出大聲或是異常的聲響
- 電源保險絲燒掉或是斷路器頻繁的跳掉
- 水或其他物體進入設備中，或是從設備中流出

請勿試圖自行修理！請立即與您的授權服務供應商聯絡！

常見問題

下列問題並非故障，且在大多情形中並不需要維修。

問題	可能成因
按壓 開/關 鈕時冷氣機沒有啟動	冷氣機有三分鐘的保護功能，用於防止設備過載。在被關閉的三分鐘內無法重新啟動冷氣機。
冷氣機從冷氣模式轉成風扇(FAN)模式	設備可能會變更其設定以避免設備內結霜。一旦溫度升高，設備將會再次以先前選擇的模式開始運轉。
	已經達到設定溫度，在此點時設備會關閉壓縮機。當溫度再度浮動時，設備就會繼續運轉。
室內機排出白霧	在潮濕的區域中，房間空氣與冷氣空氣間的巨大差異就會造成白霧。
室內機與室外機都排出白霧	在暖氣模式中重新啟動設備時，可能會因為除霜程序中產生的濕氣而排放出白霧。(暖氣模式不適用於淨冷型號)
室內機發出噪音	當送風葉重設其位置時，可能會發出急流的空氣聲。
	因為設備的塑膠零件膨脹與收縮，在運轉設備後可能會發出吱吱聲。
室內機與室外機都發出噪音	運轉期間發出低聲的嘶嘶聲：這是正常現象，是因為雪種氣體流經室內和室外機引起的。
	系統啟動時、剛剛停止運轉或除霜時發出低聲的嘶嘶聲：此噪音為正常現象，是因為雪種氣體停止或改變方向所致。
	吱吱聲：運轉期間之溫度改變造成塑膠與金屬零件的正常膨脹與收縮會發出吱吱聲。

室外機發出噪音	設備將會根據其當前的運轉模式而產生不同的聲響。
室內機或室外機 排出灰塵	長期不使用可能會在設備中累積灰塵，設備啟動時會將其排出。長期不使用時覆蓋住設備可以減緩此狀況。
設備發出惡臭	設備會吸收環境中的臭味(像是傢俱、煮食、香煙等)，這些會在運轉期間排出的味道。
	設備的濾網已經發霉而需要清潔。
室外機的風扇沒有 運轉	運轉期間，會控制風扇速度好讓產品運轉最佳化。
運作不穩定、無法 預測、或是設備沒 有反應	<p>手機基地台與遠端強波器的干擾可能會造成設備故障。</p> <p>在此情形中，請嘗試下列動作：</p> <ul style="list-style-type: none"> • 切斷電源，然後再重新連接。 • 按壓遙控器上的開/關按鈕重新開始運轉。

注意事項:

若問題持續未改善，請洽當地經銷商或離您最近的客服中心，提供詳細的設備故障說明還有您的冷氣機型號和產品序號(S/N) (在冷氣機銘牌旁邊) 給他們。

故障排除

發生故障時，請於您聯絡維修公司之前先檢查下列各點：

問題	可能成因	解決方案
製冷效能不佳	溫度設定可能高於周遭室溫	降低溫度設定。
	室內或室外機的熱交換器太髒	清潔受影響的熱交換器。
	空氣濾網太髒	根據指示取下濾網並清潔。
	設備的進氣口或是出風口堵塞	關閉設備，排除堵塞情形然後再啟動設備。
	門窗打開	設備運轉時請確認所有門窗都已關閉。
	陽光產生過多熱度	高溫或強烈日曬期間請關窗並拉上窗簾。
	室內有過多熱源(人、電腦、電器用品等)	減少熱源的數量。
	因為外洩或是長期使用造成雪種過少	檢查是否有外洩情形，必要時請重新密封並補滿雪種。
	靜音功能已啟用(選用功能)	靜音功能會降低運轉頻率而讓產品效能下降。請關閉靜音功能。
設備沒有運轉	電源故障	等候電力恢復
	電源被關閉	開啟電源
	保險絲燒掉	更換保險絲
	遙控器電池沒電	更換電池
	設備的三分鐘保護啟動	重啟設備後等待三分鐘
	計時器已啟動	關閉計時器
設備頻繁的啟動與關閉	系統內的雪種過多或過少	檢查是否有外洩情形，並使用雪種重新裝填系統。
	不可壓縮的氣體或是濕氣進入系統中	疏散並使用雪種重新裝填系統
	壓縮機故障	更換壓縮機
	電壓過高或過低	安裝穩壓器以調節電壓
	室外溫度極端的低	使用輔助的加熱裝置
	冷空氣透過門窗進入	使用期間確認所有門窗皆已關閉
	因為外洩或是長期使用造成雪種過少	檢查是否有外洩情形，必要時請重新密封并補滿雪種

指示燈持續閃爍	設備可能會停止運轉或是持續安全的運轉。若指示燈持續閃爍或是出現錯誤代碼，請等候約十分鐘。問題可能會自行解決。
室內機的視窗顯示器上出現錯誤代碼： <ul style="list-style-type: none"> • E(x), P(x), F(x) • EH(xx), EL(xx), EC(xx) • PH(xx), PL(xx), PC(xx) 	如果沒有解決，請切斷電源然後再次連接電源。再啟動設備。 若問題持續未改善，請切斷電源並聯絡信興電器服務中心有限公司。

注意事項:若在執行過上述檢測與診斷後問題持續未改善，請立即關閉您的設備並與信興電器服務中心有限公司聯絡。

配件

冷氣機系統隨附以下附件，使用所有安裝零件和附件安裝冷氣機。安裝不當可能導致漏水、觸電和火災，或導致設備故障。空調不包含的物品必須單獨購買。

名稱	數量	外形	名稱	數量	外形
說明書			遙控器	1	
排水咀			乾電池	2	
墊圈			遙控器座架	1	
固定托板	1		遙控器支架固定螺絲	2	
夾式錨具	5-8 (因型號而異)		小過濾網 (安裝機器時，必須由授權技術人員安裝在主空氣過濾器的背面)	1-2	
定位螺絲	5-8 (因型號而異)				

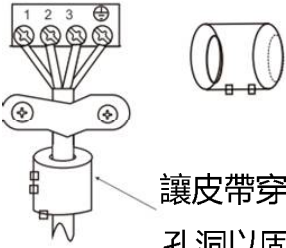
連接管組件	液體側	$\Phi 6.35$ (1/4 in)	您必須購買的零件。輸送管尺寸相關問題，請諮詢經銷商。
		$\Phi 9.52$ (3/8 in)	
	氣體側	$\Phi 9.52$ (3/8 in)	
		$\Phi 12.7$ (1/2 in)	
		$\Phi 15.9$ (5/8 in)	
		$\Phi 19.1$ (3/4 in)	
磁性環與皮帶 (若有提供且與配件一同包裝，則請參考接線圖以將其安裝於連接電纜上。)	 <p>讓皮帶穿過磁性環的孔洞以固定在電纜上</p>	因型號而異	

安裝概要 - 室內機

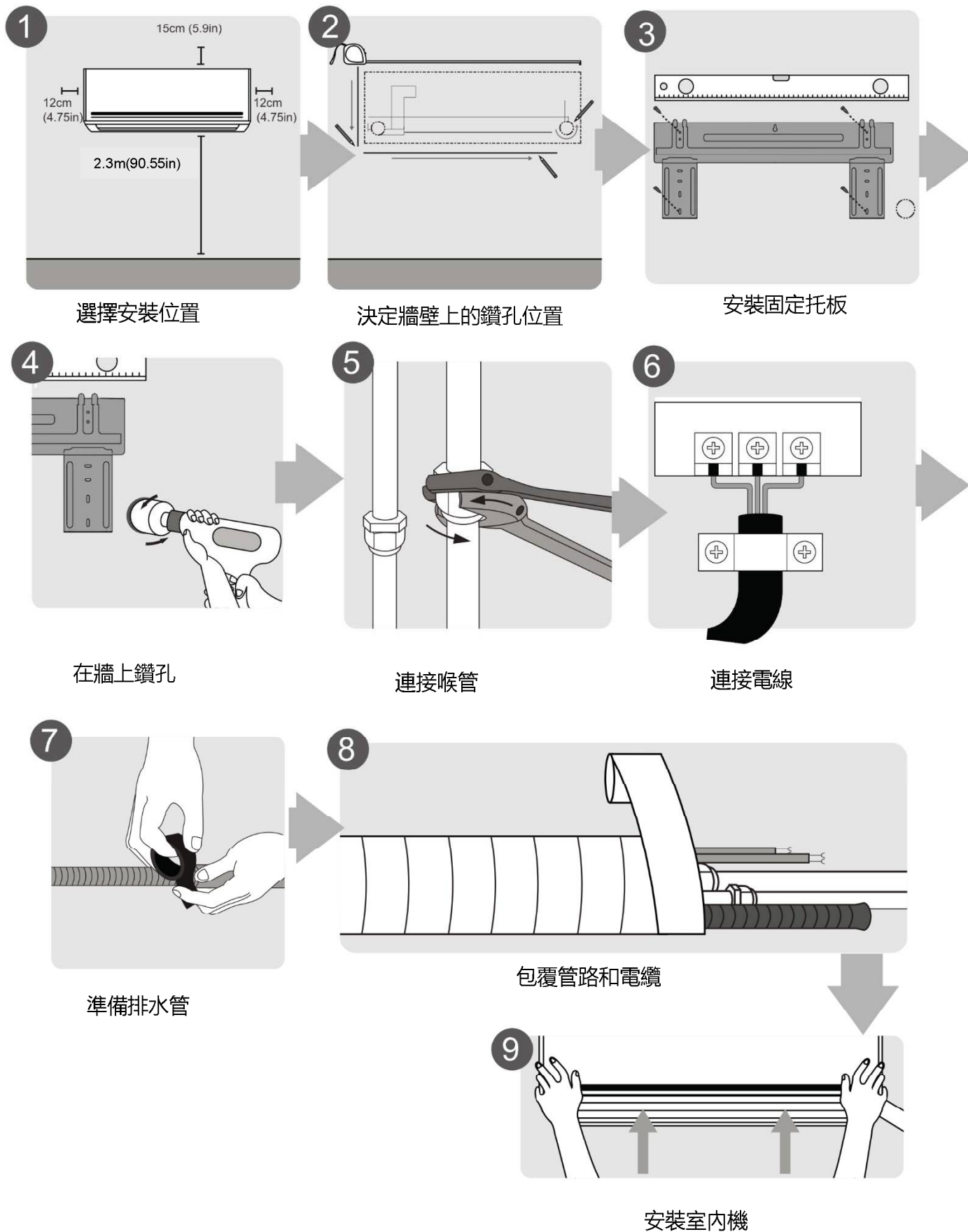

冷氣機各部件

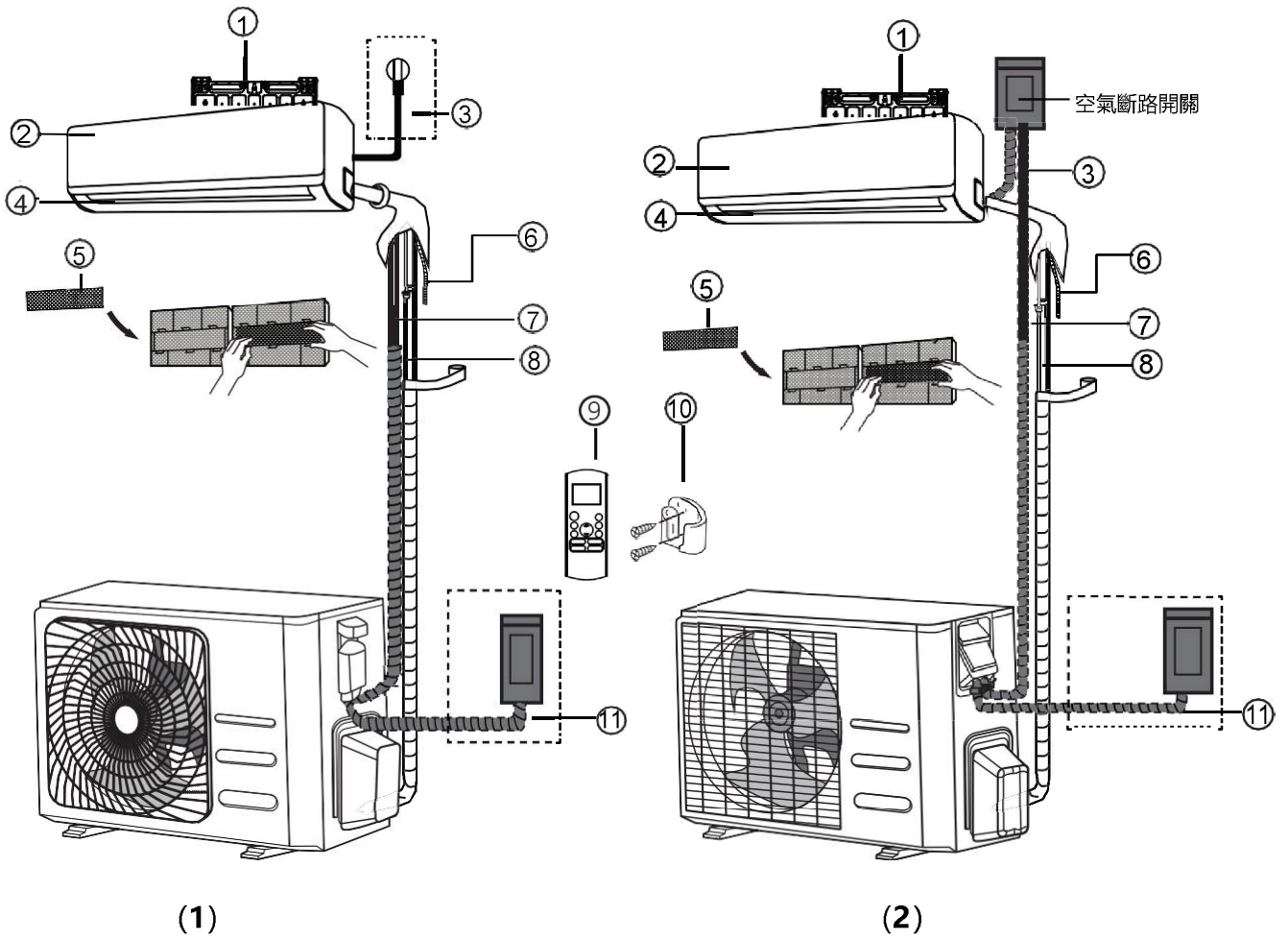

- ① 壁面固定托板
- ② 前面版
- ③ 電源線(部分機型隨機附有)
- ④ 送風葉
- ⑤ 功能性濾網(主濾網背面-部分機型適用)
- ⑥ 排水管
- ⑦ 信號線
- ⑧ 雪種管線
- ⑨ 遙控器
- ⑩ 遙控器座架(部分機型適用)
- ⑪ 室外機電源線(部分機型適用)

插圖相關說明

本手冊中的插圖僅供說明用途。您選購的室內機實際外觀可能會稍有不同。應以實際外觀為準。

室內機安裝

安裝室內機之前，請參考製造盒裝上的標籤以確認室內機的型號與室外機的型號相符。

安裝指示 – 室內機

步驟1: 選擇安裝位置

安裝室內機之前，您必須選擇適當的位置。下列是能協助您選擇設備適當位置的標準。

正確的位置能滿足下列標準：

- 空氣流通良好
- 便利的排水
- 設備產生的噪音不會打擾他人
- 堅固牢靠—此位置不會振動
- 足夠穩健可支撐設備重量
- 與其他電氣設備相距一公尺的位置（例如：電視、收音機、電腦）

請勿 將設備安裝在下列地點：

- ⊗ 接近任何高溫、蒸汽或可燃氣體
- ⊗ 接近易燃物品，如窗簾或衣服
- ⊗ 接近任何可能阻礙空氣流通的障礙物
- ⊗ 靠近門口
- ⊗ 位於陽光直射的地方

牆上開孔相關說明：

若沒有固定的雪種管線：

在選擇位置時，請注意您應留出足夠的空間用於連接室內和室外機之信號線與雪種管線的牆孔（請參閱牆上鑽孔以連接管線步驟）。

所有管線的預設位置都在室內機的右側（面向設備時）。但是，該設備可以容納左右兩側的管道。

請參閱下圖以確認與牆壁及天花板留有適當距離：

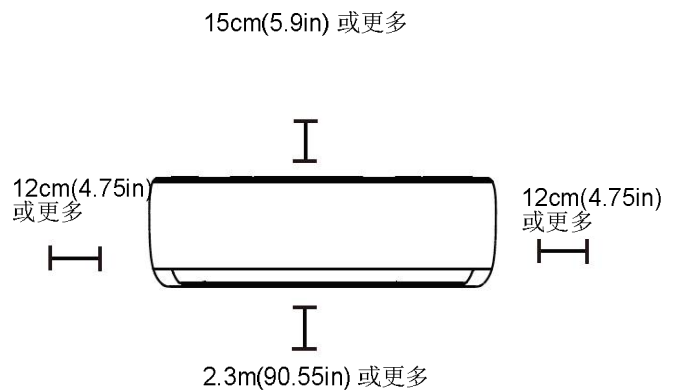

步驟2: 從機器上取出固定托板

固定托板是您將室內機安裝於其上的裝置。

- 取下連接固定托板與室內機背面的螺絲。
- 用提供的螺釘將安裝板固定在牆上。確保安裝板是平靠在牆上的。

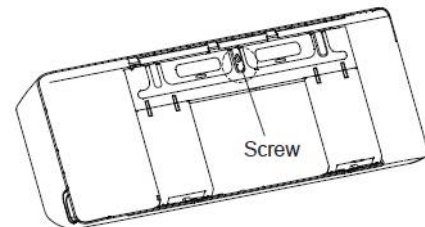

插圖相關說明

若牆壁是由磚、混凝土或類似材質製成，則請在牆壁上鑽5毫米直徑（0.2英寸直徑）的孔並插入所提供的套筒錨具。然後將螺釘直接轉入夾具固定器，將固定托板固定到牆壁上。

3: 於牆上鑽孔以連接銅管

1. 根據固定托板的位置確定壁上鑽孔的位置。請參閱下一頁的固定托板尺寸。
2. 使用65毫米 (2.5英寸) 或90毫米 (3.54英寸) (視型號而定) 的空心鑽，在牆上鑽一個洞。確認以略微向下的角度鑽孔，讓孔的室外端低於室內端約5毫米到7毫米 (0.2-0.275in) 。此可確保適當的排水。
3. 將保護性牆套放入孔中。此可保護鑽孔邊緣，並在完成安裝過程後協助密封。



小心

於牆上鑽孔時，請務必避開電線、管道和其他敏感零部件。

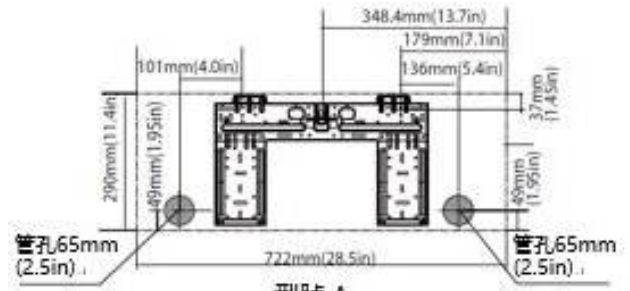
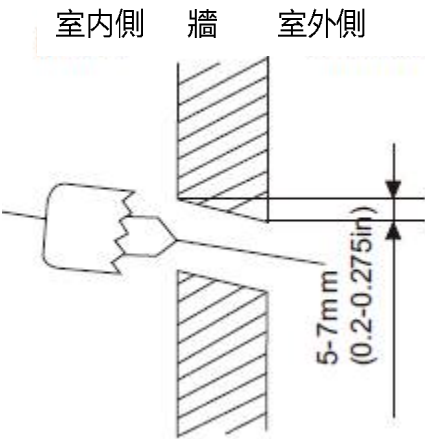

型號 A

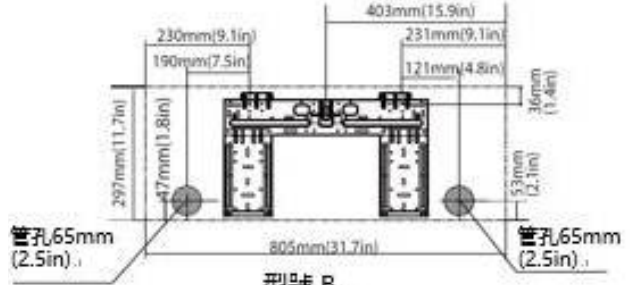

型號 B

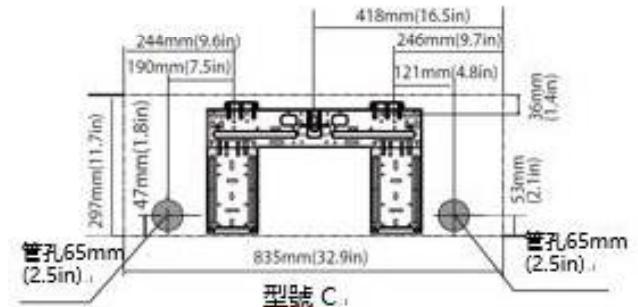

型號 C

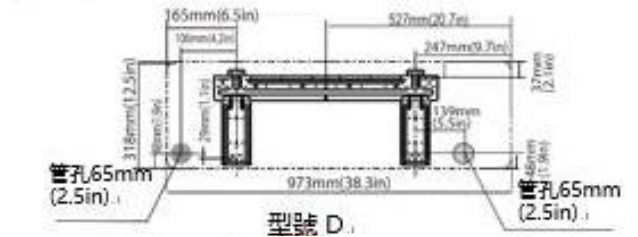

型號 D

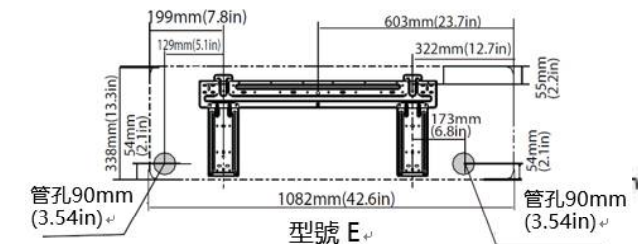

型號 E

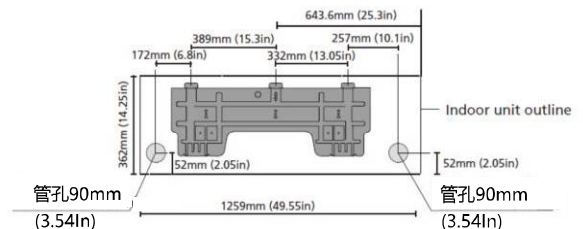

F

固定托板尺寸

不同型號的固定托板皆不同。為了確保您有足夠的空間安裝室內機，右側的圖表顯示出不同的固定托板類型以及下列尺寸：

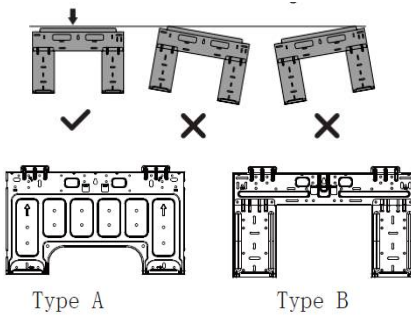

注意：當氣體側連接管為 $\Phi 16\text{mm}$ (5 / 8in) 或更大時，壁孔應為90mm (3.54in) 。

步驟4: 準備雪種管

雪種管位於連接到設備背面的絕緣套筒內。在讓雪種管穿過牆壁上的開孔之前，您必須先將管線準備好。

1. 根據壁孔相對於安裝板的位置，選擇雪種管的位置。

2. 如果壁孔在冷氣機後面，則將拆卸板保持在原位。

如果壁孔在室內機的側面，請從室內機的側面剪掉預留的塑料拆卸面。折角開一個插槽，您的管道可通過該插槽伸出。如果塑料面板很難用手卸下，請使用尖嘴鉗。

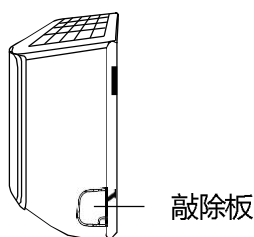

3. 如果現有的連接管線已經嵌入牆壁中，請直接繼續前進到連接排水管的步驟。如果沒有嵌入式管道，則請將室內機的雪種管線連接到將會連接室內機與室外機的連接管線上。

請參閱本手冊的雪種

管線角度相關說明

管道會以四個不同角度伸出室內機：

左手側，右手側，左後方，右後方

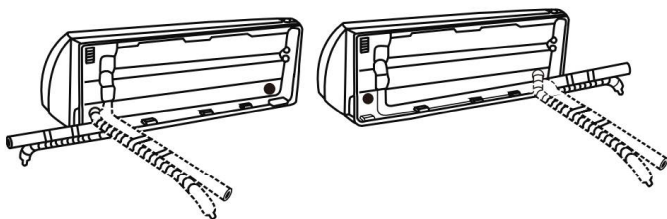

⚠ 注意

在讓管線彎曲時，請務必要極度小心不要讓管線凹陷或損壞。管線中的任何凹陷都會影響設備的效能。

步驟5: 連接排水軟管

默認情況下，排水軟管連接在設備的左側（當您面對設備的背面時）。但是，它也可以連接到右側。為確保正確排水，將排水軟管連接到製冷劑管道離開設備的那一側。將排水軟管的拉緊力（另購）連接到防雨軟管的末端。

- 用特氟龍膠帶牢固地包裹連接點，以確保良好的密封並防止洩漏。
- 對於排水軟管將留在室內的那部分，用泡沫管絕緣材料包裹以防止冷凝。
- 拆下空氣過濾器，然後向排水盤中倒入少量水，以確保水從設備中順利流出。

排水管放置注意事項

確保根據下圖佈置排水軟管。



確保排水軟管沒有扭結或凹痕，以確保正確排水。

排水軟管中的扭結會形成水珠。



排水軟管中的扭結會形成水珠。

請勿將排水軟管的末端放在水中或盛水的容器中。這將防止適當的排水。

堵塞未使用的排水孔

為防止意外洩漏，您必須使用隨附的橡膠塞堵住未使用的排水孔。

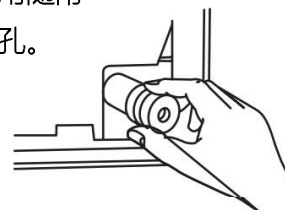

！執行電氣作業之前，請詳閱這些規定

1. 所有接線都必須符合當地與國家電氣規範之規定，並須由合資格之電工安裝。
2. 所有電氣連接都必須根據室內和室外機面板上所示之電氣連線圖進行。
3. 若電源供應出現嚴重的安全問題，請立即停止作業。並在妥善解決安全問題之前應拒絕安裝設備。
4. 電力的電壓應在額定電壓的90-110%範圍內。電力不足會導致故障、觸電或火災的危險。
5. 如果將電源連接到固定接線，則應安裝電湧保護器和主電源開關。
6. 若將電源與固定線路連接，則必須在固定線路中安裝能夠切斷所有電極，且各觸點間距至少分隔1/8英寸（3毫米）的開關或斷路器。合格技師必須使用經核可的斷路器或開關
7. 設備僅可連接到單一支的電路插座。請勿在同一個插座上連接另一台設備。
8. 確認冷氣機有正確接地。
9. 每條電線都必須緊固連接。接線鬆動會造成端子過熱而導致產品故障以及可能的火災情形。
10. 請勿讓電線接觸到或是放在雪種管、壓縮機或設備內的任何活動零件上。
11. 若設備有輔助電子加熱器，則必須安裝在距離任何易燃材質至少1公尺（40英寸）以外之處。
12. 為避免觸電，切勿在電源關閉後立即觸摸電氣組件。關閉電源後，請務必等待 10 分鐘或更長時間，然後再觸摸電氣元件。

！警告

執行任何電氣或接線作業之前，請先關閉系統的主電源。

步驟6: 連接信號線和電源線

信號線能讓室內機與室外機間進行通訊。在準備連接之前，首先須選擇正確的電纜尺寸。

電纜類型

- 室內電源線 (若適用): H05VV-F或H05V2V2-F
- 室外電源線: H07RN-F或H05RN-F
- 信號線: H07RN-F

電源線與信號線的最小截面積 (供參考)

設備的額定電流X (A)	電線截面積 (mm ²)
≤6	0.75
6<X≤10	1.0
≤16	1.5
16<X≤25	2.5
≤32	4.0
32<X≤40	6.0

選擇正確的電纜尺寸

所需的電源線、信號線、保險絲和開關的尺寸是由冷氣機的最大電流來決定。最大電流(額定電流)於冷氣機側面板上的銘板指示。

！警告

必須嚴格按照室內機前面板背面的接線圖執行所有接線。

1. 打開室內機的前面板。
2. 使用螺絲起子打開設備右方的接線盒蓋。這會讓接線板露出來

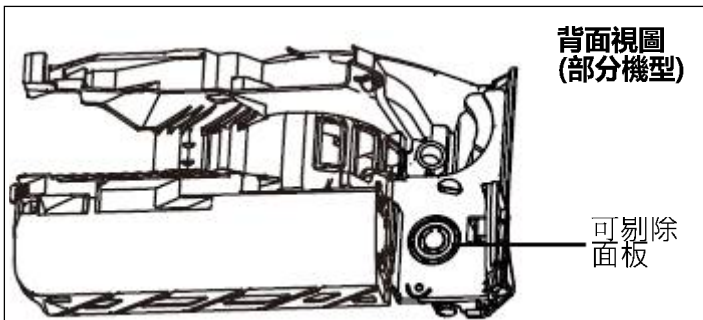
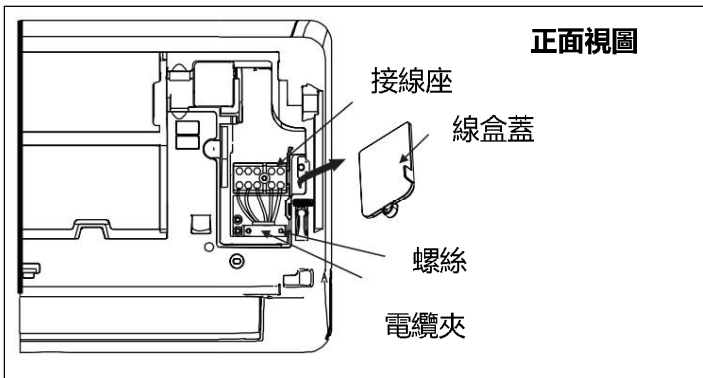

注意:

- 對於帶有導管的單元來連接電纜，請卸下大的塑料“可剔除面板”，以創建一個插槽，通過該插槽可以安裝導管。
- 對於帶有五芯電纜的單元，請卸下中間的小型實用敲落面板，以創建一個插槽，電纜可以通過該插槽引出。
- 如果塑料面板很難用手卸下，請使用尖嘴鉗。

3. 鬆開接線端子下方的電纜夾，並將其放在側面。
4. 面對本機的背面，卸下左側底部的塑料面板。
5. 將信號線從設備的背面到正面穿過此插槽。
6. 面對設備的正面，根據室內設備的接線圖連接電線，連接u型接線片，然後將每根電線牢固地擰入其相應的端子。
7. 檢查以確保每個連接都牢固後，使用電纜夾將信號電纜固定到設備上。擰緊電纜夾，緊緊地向下。
8. 裝回設備正面的電線蓋，并裝回背面的塑料面板。

警告

不要混用火線和零線，這很危險的，並可能導致空調裝置發生故障。

接線注意

設備和地之間的接線過程可能略有不同。

步驟7：包裝和電纜

在將管道，排水軟管和信號電纜穿過壁孔之前，必須將它們捆綁在一起以節省空間，保護它們並使其絕緣。

1. 捆紮排水軟管，製冷劑管道和信號電纜，如下所

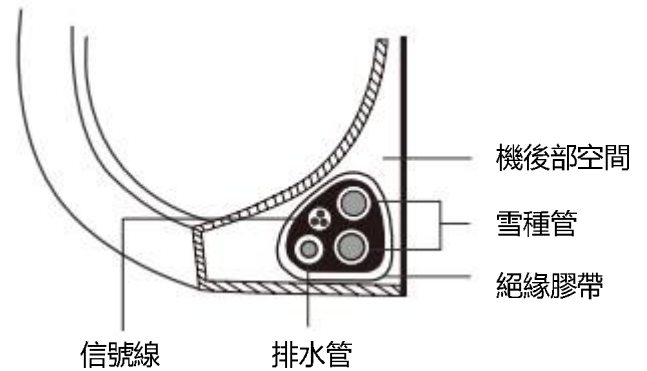

2. 使用乙烯基膠帶將排水軟管連接到製冷劑管的底側。
3. 使用絕緣膠帶將信號線，製冷劑管道和排水軟管緊緊纏繞在一起。仔細檢查所有物品是否捆綁在一起。

排水管必須位於底部

確認排水管位於捆束的底部。若將排水管放在捆束的頂部會造成排水盤溢出，這會導致火災或滲水損壞。

請勿將信號線與其他線路交纏

將這些項目捆綁在一起時，請勿將信號線與任何其他接線交纏或交叉。

請勿包附住管線的端點

包覆捆束時，請保持管道末端不要被包覆住。您需要在安裝過程結束時使用它們以測試是否有外洩(請參閱本手冊的**電氣檢查與外洩檢查**小節)。

步驟8: 安裝室內機

若您安裝新的連接管線與室外機，請執行下列步驟：

1. 若您已經透過牆上開孔穿過雪種管線，請繼續執行步驟4。
2. 否則，請仔細檢查雪種輸送管的末端是否已經密封，以防止灰塵或異物進入管道。
3. 將包覆好的雪種輸送管、排水管以及信號線慢慢地穿過牆上的開孔。
4. 將室內機的上方鉤在固定托板的上鉤上。
5. 藉由在設備的左側和右側施加輕微壓力，檢查設備是否穩固地鉤在安裝位置上。設備不應搖晃或移位。
6. 使用均勻的壓力，下壓設備的下半部分。繼續向下推直到裝置卡在固定托板底部的鉤子上。
7. 再一次，藉由在設備的左側和右側施加輕微壓力來檢查設備是否安裝穩固。

如果雪種管線已嵌入牆內，則請執行下列步驟：

1. 將室內機的上方鉤在固定托板的上鉤上。
2. 使用支架或楔形物支撐設備，讓您有足夠空間來連接雪種管線、信號線與排水管。

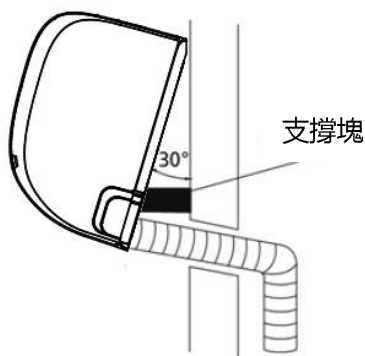

3. 連接排水管與雪種管線（請參閱本手冊的雪種管線連接小節了解相關指示）。
4. 讓輸送管連接點暴露於外，以執行外洩測試（請參閱本手冊的電氣檢查與外洩檢查小節）。
5. 外洩測試後，請使用絕緣膠帶包覆連接點。
6. 拆下支撐裝置的支架或楔形物。
7. 使用均勻的壓力，下壓設備的下半部分。繼續向下推直到裝置卡在固定托板底部的鉤子上。

室內機位置是可調整的

請記住，固定托板上的掛鉤比設備背面的開孔小。若您發現沒有足夠的空間連接嵌入式輸送管與室內機，則可以向左或向右調整設備約30-50mm (1.18-1.96in)，依型號而有不同。



左或右移動

室外機安裝

請遵循當地的法規來安裝設備，不同地區之間可能會略有不同。

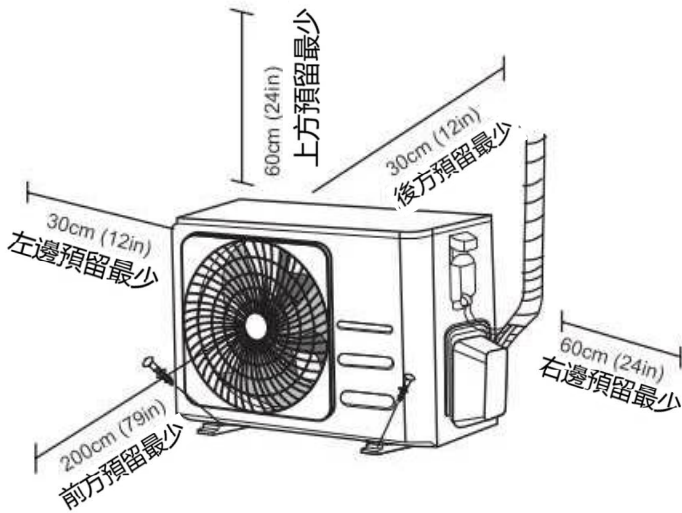

安裝指示 - 室外機

步驟1: 選擇安裝位置

安裝室外機之前，您必須先選擇合適的位置。下列是可協助您為設備選擇合適位置的標準。正確的安裝位置滿足下列標準：

- 滿足安裝空間要求中顯示的所有空間要求
- 良好的空氣循環和通風
- 堅固牢靠—此位置可支撐設備且不會振動
- 設備產生的噪音不會打擾他人
- 可長時間避免陽光直射或下雨
- 如果預計會降雪，請將設備抬高至底墊上方，以防止結冰和盤管損壞。將設備安裝在足夠高的位置，以使其超過平均積雪量。最小高度必須為18英寸。

請勿將設備安裝於下列地點：

- 接近會阻礙進氣口與出風口之障礙物處
- 接近公共街道、擁擠的區域，或者設備噪音會打擾他人之處
- 接近熱空氣排放會受傷害的動物或植物附近之處
- 接近任何易燃氣體來源之處
- 暴露於大量灰塵中的地方
- 暴露於過量含鹽空氣中的地方

極端天氣的特殊注意事項

如果設備暴露在大風中：

安裝裝置時，出風口風扇應與風向成90°角。如果需要，請在設備前面建立一個屏障，以保護其免受強風的侵襲。

參見下圖。

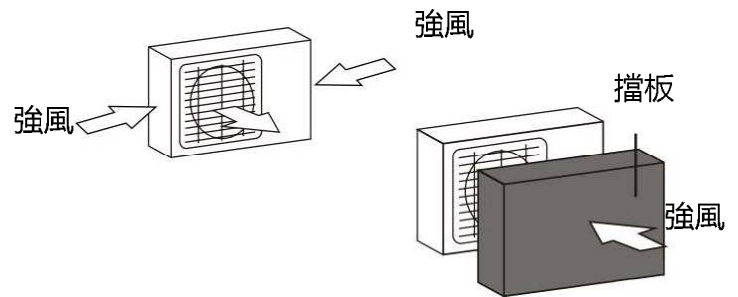

若冷氣機經常暴露在豪雨或暴雪中：
在單元上方建一個遮蓋物，以防止雨水或下雪。請小心切勿阻擋設備周圍的氣流。

若冷氣機經常暴露在含鹽的空氣中（海邊）：
請使用專門設計用於抵抗腐蝕的室外機。

步驟2: 安裝排水接頭(僅限熱泵型號)

熱泵型號需要有排水接頭。在將室外機固定於適當位置之前，必須在設備底部安裝排水接頭。請注意，根據室外機的類型不同，有兩種不同類型的排水接頭。

如果排水接頭帶有橡膠密封件（請參見圖A），請執行以下操作：

1. 將橡膠密封墊安裝在連接到室外機的排水接頭末端。
2. 將排水接頭插入設備底盤的孔中。
3. 旋轉排水接頭90°，直到其朝向設備前部卡入適當位置。
4. 將排水管延長件（非隨機供應配件）與排水接頭連接，以在重新引導設備產生的水。

如果排水接頭沒有附橡膠密封墊（見圖B），請執行下列步驟：

1. 將排水接頭插入設備底盤的孔中。排水接頭卡入適當位置。
2. 將排水管延長件（非隨機供應配件）與排水接頭連接，以在重新引導設備產生的水。

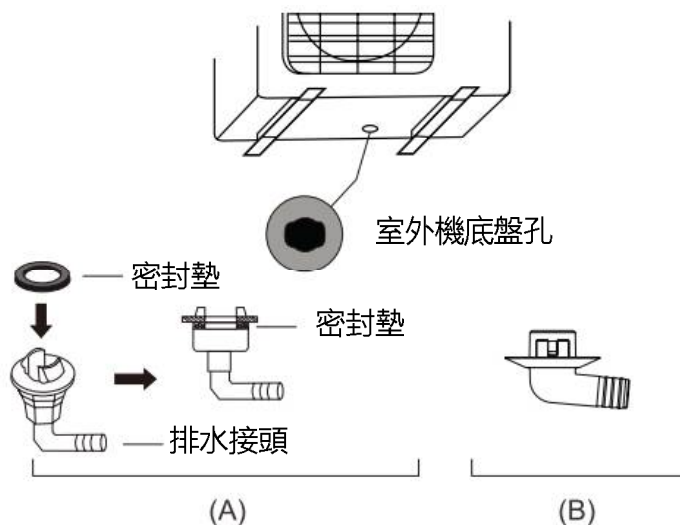

步驟3: 固定室外機

室外機可以用螺栓（M10）固定在地面或壁掛式支架上。根據以下尺寸準備單元的安裝底座。

設備安裝尺寸

下列是不同的室外機之尺寸與其安裝腳之間的距離列表。請根據下列尺寸來準備設備的安裝底座。

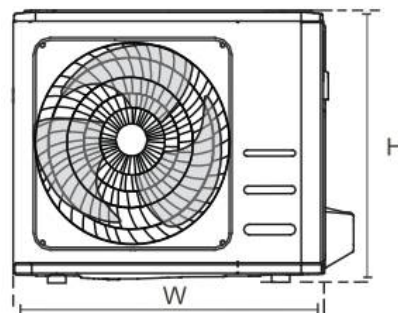
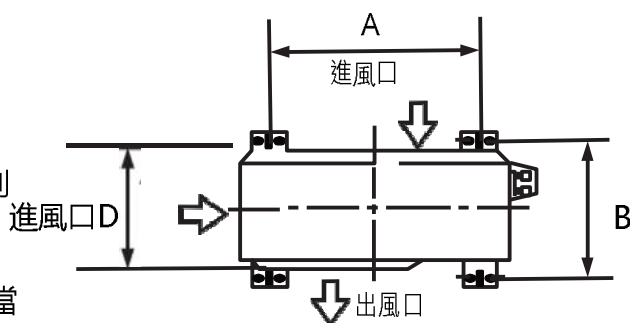

❗ 在寒冷氣候中

在寒冷氣候中，請確認排水管要盡可能垂直，以確保能快速排水。若排水過慢，水可能會在管中結凍而讓設備淹水。

室外機尺寸(mm)		安裝尺寸	
寬W x高H x深D		距離 A (mm)	距離B (mm)
RU-S9KI RU-S12KI	720x495x270 (28.3"x19.5"x10.6")	452 (17.8")	255 (10.0")
RU-S18KI	765x555x303 (30.1"x21.8"x11.9")	452 (17.8")	286(11.3")

如果要將設備安裝在地面或混凝土安裝平台上，請執行以下操作：

1. 根據尺寸圖標記四個膨脹螺栓的位置。
2. 在膨脹螺栓上預先鑽孔。
3. 將螺母放在每個膨脹螺栓的末端。
4. 將膨脹螺栓錘入預鑽孔中。
5. 從膨脹螺栓上卸下螺母，然後將室外機放在螺栓上。
6. 將墊圈放在每個膨脹螺栓上，然後裝回螺母。
7. 用扳手擰緊每個螺母，直到緊貼

 **警告**

在混凝土材質上鑽孔時，建議請保護好眼睛。

若您將該設備安裝在壁掛式支架上，請執行下列步驟：

 **小心**

在安裝壁掛式裝置之前，請確認牆壁是由實心磚、混凝土或類似的堅固材質製成。
牆必須至少能夠支撐設備四倍的重量。

1. 根據“設備安裝尺寸”圖表中的尺寸標記四個膨脹螺栓的位置。
2. 預先鑽好膨脹螺栓所需的開孔。
3. 在每個膨脹螺栓的末端放置一個墊片與螺帽。
4. 將膨脹螺栓轉入安裝支架上的孔，將安裝支架固定在適當位置，然後將膨脹螺栓敲到牆中。
5. 確認安裝支架是否水平。
6. 小心地抬起裝置並將其安裝腳放在支架上。
7. 將設備牢牢固定在支架上。
8. 如果允許，請在設備上安裝橡膠墊圈以減少振動和噪音

步驟4: 連接信號線與電源線

室外機的接線板受到冷氣機側面的電線蓋保護。

接線蓋內側印有完善的接線圖。



警告

在執行任何電氣或接線工作之前，請關閉冷氣機的主電源。

1. 準備電纜進行連接:

使用正確的電纜

請選擇正確的電纜，請參閱第 22 頁的“電纜類型”。

選擇正確的電纜尺寸

所需電源線、信號線、熔斷器、開關的尺寸由機組的最大電流決定。最大電流在裝置側板上的銘牌上標明。

最大電流顯示在冷氣機側面板上的銘牌上。

注意：在北美，請根據設備銘牌上指示的最小電路載流量選擇合適的電纜尺寸。

- 使用剝線鉗，從電纜的兩端剝去橡膠套，露出內部約40mm (1.57in) 的電線。
- 剝去電線末端的絕緣層。
- 使用壓線鉗壓接導線末端的u型接線片。

注意

壓接電線時，請確認將載電線（“L”）與其他電線區分開來。



警告

所有接線工作必須嚴格按照位於內部的接線圖進行室外機的線罩。

- 轉下電線蓋並將其拆下。
- 轉下接線板下方的電線固定片並將其放在旁邊。
- 將電線的顏色/標籤與接線板上的標籤相配，然後將每根電線緊固地轉到相對應的端子上。
- 檢查確認每個連接處皆已緊固後，請將電線環繞以防止雨水流入端子中。
- 使用電線固定片將電纜固定到設備上。請將電線固定片向下轉緊。
- 使用PVC電氣膠帶將未使用的電線絕緣。妥善放置，好讓它們不會觸碰到任何電氣或金屬零件。

- 更換冷氣機側面的電線蓋，然後鎖到適當位置上

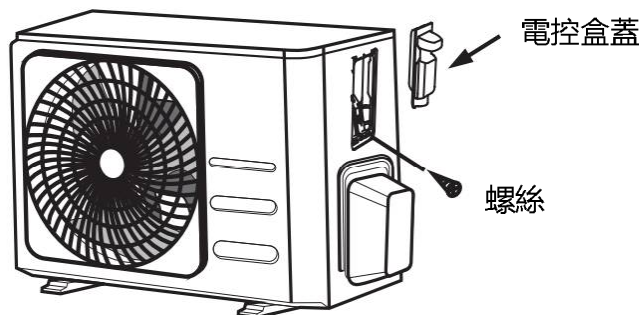

注意：如果電纜夾的外觀如下，請根據電線的直徑選擇合適的通孔。

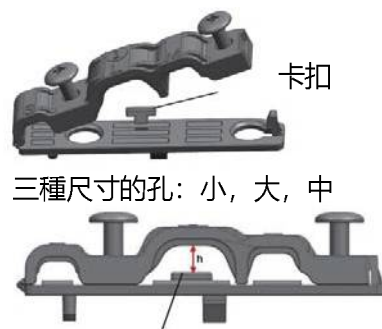

當電纜緊固不充分時，請使用搭扣將其支撐起來，以便將其牢固地夾緊。

雪種管路連接

連接製冷劑管道時，**請勿**讓指定製冷劑以外的其他物體或氣體進入設備。其他氣體或物質的存在會降低設備的運轉能力，並可能在製冷循環中引起異常高壓。這會導致爆炸和傷害。

管線長度相關說明

雪種管線的長度會影響設備的效能和能源效率。在輸送管長度為5米的設備上測試明目效率。

需要最短長度為3米的輸送管，以減少振動和過大的噪音。

至於特定熱帶地區，雪種輸送管的最大長度不應超過10米。

請參閱下表以了解管線最大長度和落差高度的規格。

機型	能力 (BTU/h)	最大長度 (m)	最大落差高度 (m)
R410A, R32 變頻分體式 冷氣機標準管長5米	< 15,000	25	10
	≥ 15,000 and < 24,000	30	20
	≥ 24,000 and < 36,000	50	25

連接指示—雪種管

1: 切割雪種管

在準備雪種輸送管時，需特別小心地切割以及擴口。此可確保有效的運轉並將未來維護的需求降到最低。

至於R32雪種機型，管道連接點必須安裝在室外。

1. 測量室內機和室外機之間的距離。
2. 使用切管刀，將管道切割的比測得之距離略長。
3. 請確認以90°的完美角度切割輸送管。

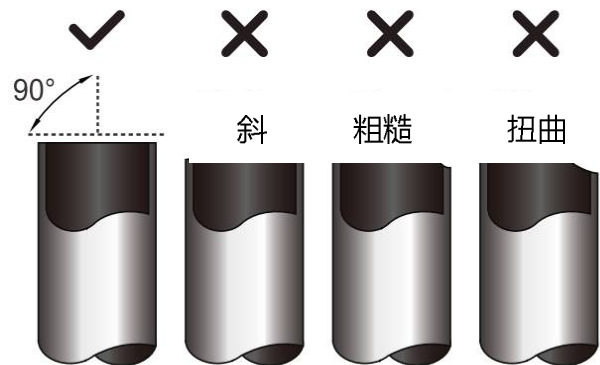

切割時請勿讓雪種管變型

切割時要格外小心，切勿損壞輸送管、讓其凹陷或使其變形。此將大幅降低設備的加熱效率。

2: 去除毛刺

毛邊會影響雪種管線連接的氣密密封。必須完全清除。

1. 將雪種管向下傾斜，以防止毛邊掉入雪種管中。
2. 使用鉸刀或除毛邊工具，清除所有切割部份產生的毛邊。



步驟3: 輸送管末端擴口

適當的擴口對於密封的達成是不可或缺的。

1. 清除切割輸送管時產生的毛邊後，請用PVC膠帶密封兩端以防止異物進入輸送管。
2. 用絕緣材質保護輸送管。
3. 在輸送管兩端放置擴口螺帽。確認它們朝向正確的方向，因為在擴口後就無法將其戴上或是改變方向。
4. 準備好執行擴口作業時，請從輸送管末端取下PVC膠帶
5. 在輸送管末端夾住擴口外側。輸送管末端必須根據下表中所示的尺寸延伸到擴口外側的邊緣以外。

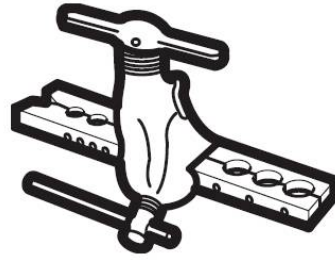
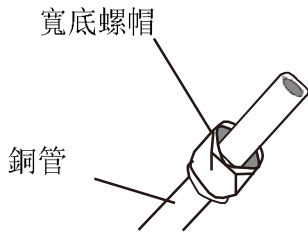

雪種管 外徑(mm)	A (mm)	
	最小	最大
Ø 6.35 (Ø 0.25")	0.7 (0.0275")	1.3 (0.05")
Ø 9.52 (Ø 0.375")	1.0 (0.04")	1.6 (0.063")
Ø 12.7 (Ø 0.5")	1.0 (0.04")	1.8 (0.07")
Ø 15.9 (Ø 0.63")	2.0 (0.078")	2.2 (0.086")
Ø 19.1 (Ø 0.75")	2.0 (0.078")	2.4 (0.094")

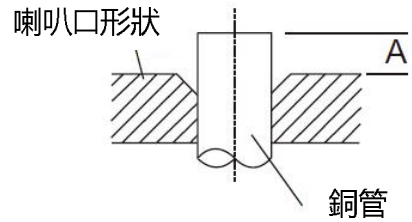

- 將擴口工具放在外側上。
- 順時針轉動擴口工具的把手，直到輸送管完全展開。
- 取下擴口工具和擴口外側，然後檢查管道末端是否有裂縫，且甚至是否有外擴。

步驟4: 連接管道

請勿使用過大的扭力或以任何方式使輸送管變形。您應先連接低壓輸送管，然後再連接高壓輸送管。

最小彎曲半徑

彎曲連接雪種管時，最小彎曲半徑為10cm。

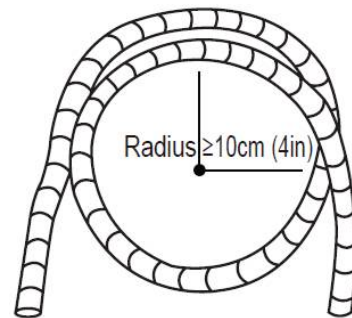

連接製冷劑管路與室內機的指示

- 對齊您要連接的兩個輸送管中心。
- 用手盡可能的轉緊擴口螺帽。
- 使用扳手夾緊設備管路上的螺帽。
- 在牢牢夾住設備管路上的螺帽的時候，請使用扭力扳手根據下方之扭力要求表中的扭力值來轉緊擴口螺帽。稍微鬆開擴口螺帽，然後再次轉緊。

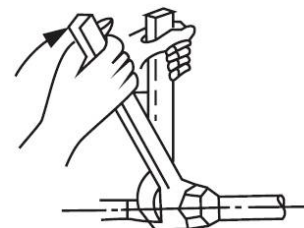
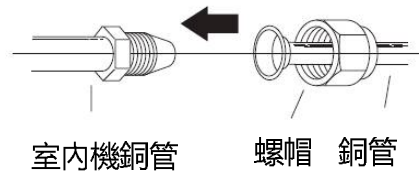

雪種管外徑(mm)	轉緊扭力 (N·cm)	喇叭口尺寸 (B) (mm)	喇叭形
Ø 6.35 (Ø 0.25")	18~20(180~200kgf.cm)	8.4~8.7 (0.33~0.34")	
Ø 9.52 (Ø 0.375")	32~39(320~390kgf.cm)	13.2~13.5 (0.52~0.53")	
Ø 12.7 (Ø 0.5")	49~59(490~590kgf.cm)	16.2~16.5 (0.64~0.65")	
Ø 16 (Ø 0.63")	57~71(570~710kgf.cm)	19.2~19.7 (0.76~0.78")	
Ø 19 (Ø 0.75")	67~101(670~1010kgf.cm)	23.2~23.7 (0.91~0.93")	

請勿使用過度扭力

過大的力量會破壞螺帽或是損壞雪種管線。不得超過上表中所示的扭力要求。

連接管線與室外機的指示

1. 從室外機側邊的填料閥上轉下蓋子。
2. 從閥門末端取下保護蓋。
3. 將擴口的輸送管末端對齊每個閥門，並用手盡可能緊地轉緊擴口螺帽。
4. 使用扳手，夾住閥體。請勿夾住密封檢修閥的螺帽。
5. 牢牢夾住閥體的同一時間，請使用扭力扳手根據正確的扭力值轉緊擴口螺帽。
6. 稍微鬆開擴口螺帽，然後再次轉緊。
7. 於剩餘的輸送管上重複步驟 3 到 6。

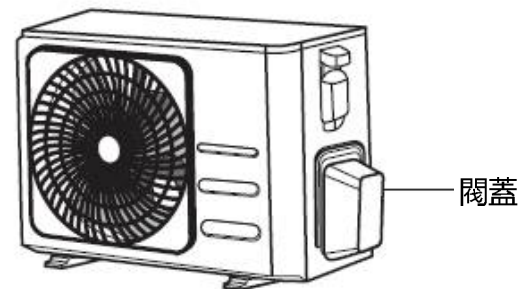

使用扳手夾住閥門主體

轉緊擴口螺帽時產生的扭力會讓閥門的其他部分折斷。

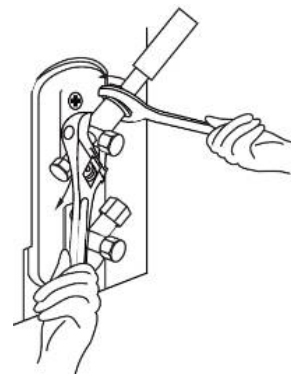

抽真空

準備與注意事項

雪種迴路中有空氣和異物會導致壓力異常升高，這會讓冷氣機受損，降低其效率並造成人員受傷。降低其效率並造成傷害。使用真空泵與歧管量規疏散雪種迴路、從系統中除去任何不凝結的氣體和水分。應在初始安裝以及重新安裝設備時執行排氣作業。

執行排氣作業之前

- 檢查以確認室內和室外機之間的高壓和低壓輸送管皆根據本手冊的雪種管線連接小節規定正確連接。
- 檢查以確認所有線路都正確連接。

抽真空指示

在使用歧管壓力表和真空泵之前，請閱讀他們的操作手冊以熟悉如何正確使用它們。

- 1.將歧管量規的充氣管與室外機低壓閥上的維修埠連接。
- 2.從歧管量規將另一個充氣管連接真空泵。
- 3.打開歧管量規的低壓側。保持高壓側之關閉。
- 4.打開真空泵以排空系統。
- 5.執行真空至少15分鐘，或直到真空壓力計讀數為-76cmHG (-105 Pa)。
- 6.關閉歧管量規的低壓側，然後關閉真空泵。
- 7.等待5分鐘，然後確認系統壓力是否沒有變化。
- 8.如果系統壓力發生變化，請參閱氣體外洩漏檢查小節了解如何檢查外洩的相關資訊。如果系統壓力沒有變化，則請從填料閥（高壓閥）上轉下蓋子。
- 9.將六角扳手插入填料閥（高壓閥）然後逆時針旋轉1/4圈的扳手打開閥門。聆聽是否有氣體外洩的聲音，然後於5秒鐘後關閉閥門。
- 10.觀察壓力計一分鐘以確認壓力沒有變化。壓力計讀數應略高於大氣壓。
- 11.從維修埠上拆下充氣管
- 12.使用六角扳手，完全打開高壓和低壓閥。
- 13.用手轉緊全部三個閥門（維修埠、高壓、低壓）上的閥蓋。若有需要，您可使用扭力扳手進一步轉緊。

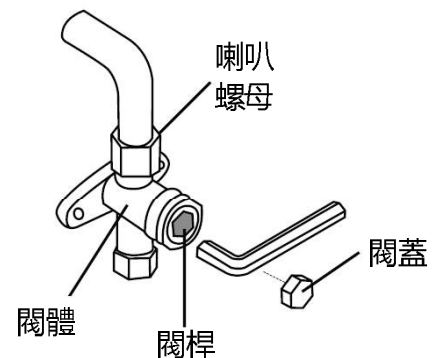
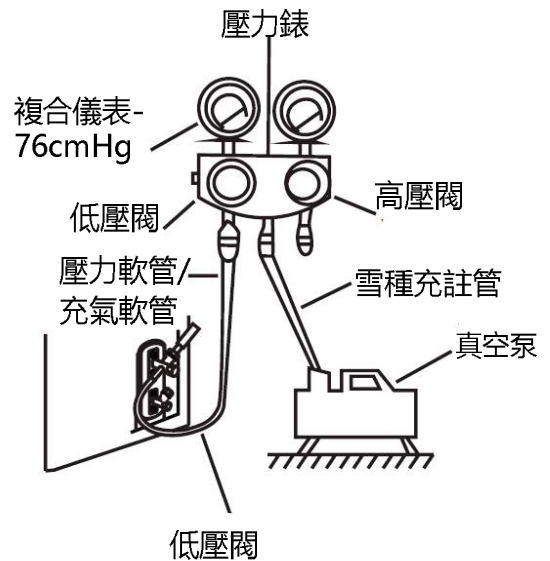

輕輕的打開閥桿

打開閥桿時，請轉動六角扳手直到碰到止動器。不要試圖用蠻力進一步打開閥門。

增添雪種相關說明

有些系統需要根據輸送管長度需要額外充填。標準輸送管長度會因當地法規而有所不同。

雪種應從室外機之低壓閥的維修埠充填。可以使用下列公式計算需充填的額外製雪種：

雪種管的長度(m)	空氣淨化法	需要額外补充的雪種	
< 標準輸送管長度5米	真空泵	N/A	
> 標準輸送管長度5米	真空泵	液體側: Ø 6.35 (ø 0.25") R410A: (輸送管長度 – 標準長度5米) x 15g/m (輸送管長度 – 標準長度5米) x 0.16oz/ft	液體側: Ø 9.52 (ø 0.375") R410A: (輸送管長度 – 標準長度5米) x 30g/m (輸送管長度 – 標準長度5米) x 0.32oz/ft



小心 請勿混合不同雪種類型。

電力與氣體洩漏檢查

測試運行之前

完成以下步驟後，才執行測試運行：

- **電氣安全檢查**—確認設備的電氣系統安全且運行正常
- **漏氣檢查**—檢查所有喇叭形螺母的連接並確認系統沒有洩漏
- 確認氣體和液體（高壓和低壓）閥門已完全打開

電氣安全檢查

安裝後，請確保已按照當地和國家法規以及《安裝手冊》安裝了所有電線。

測試運行之前

檢查接地作業

透過目測檢驗以及接地電阻測試儀器測量接地電阻。接地電阻必須小於 0.1Ω 。

測試運行期間

檢查是否有漏電

在測試運行期間，請使用電子探針與萬用表執行完善的漏電測試。

若偵測到漏電情形，請立即關閉設備並與有照電工聯絡以查出並解決漏電原因。



警告—觸電的危險

所有的接線作業都必須遵守當地與國家電氣法規的規定，且必須由有合資格之電工安裝。

氣體外洩檢查

有兩種不同方法用於檢查氣體外洩。

● 肥皂水法

使用柔軟刷具在室內機和室外機的所有輸送管連接點上塗抹肥皂水或液體清潔劑。出現氣泡就表示有外洩情形。

● 檢漏器法

若使用檢漏器，則請參閱設備的操作手冊以了解正確的使用說明。

室外機檢查點

執行氣體外洩檢查後

確認所有輸送管連接點都沒有外洩情形後，請更換室外機上的閥蓋。

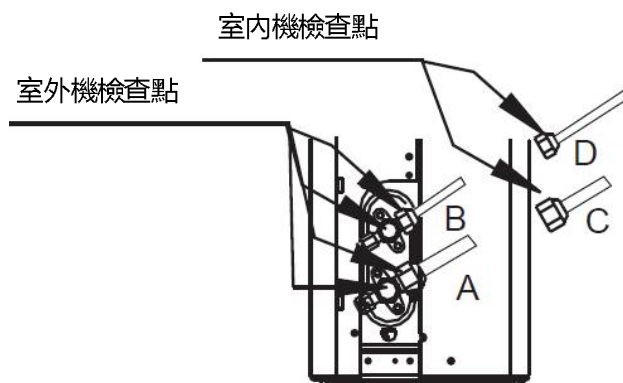

A: 低壓截止閥

B: 高壓截止閥

C&D: 室內機喇叭形螺母

測試運行

測試運行介紹

您應至少執行30分鐘的測試運行。

1. 將電源連接到本機。
2. 按遙控器上的ON / OFF按鈕啟動冷氣機。
3. 按“模式”按鈕一次滾動瀏覽以下功能：
 - 製冷 – 選擇最低溫度
 - 製暖 – 選擇可能的最高溫度(不適用)
4. 讓每個功能運行5分鐘，然後執行以下檢查：

需執行的檢核清單	通過/失敗	
無漏電		
設備已正常接地		
所有電氣端子皆已適當覆蓋		
室內和室外機皆穩固安裝		
所有輸送管連接點皆無外洩情形	室外 (2):	室內(2):
經由排水管正常排水		
所有管線皆正確絕緣		
設備正確執行製冷功能		
設備正確執行製暖功能		
室內機的送風葉正確轉動		
室內機會回應遙控器		

雙重檢查輸送管連接處

在運作期間，雪種迴路的壓力會增加。這可能會顯露出初次外洩檢查期間沒有出現的外洩情形。在測試運行期間花些時間再次檢查所有雪種輸送管連接點是否有外洩情形。請參閱氣體外洩檢查小節取得指示。

5. 成功完成測試運行後，且您確認檢核清單中需執行的所有檢查點都已通過測試，則請執行下列步驟：
 - a. 使用遙控器，讓設備恢復到正常運轉溫度。
 - b. 使用絕緣膠帶，包附好您在室內機安裝過程中留下尚未覆蓋的室內冷煤輸送管連接處。

若周遭溫度低於 17°C (62°F)

當周遭溫度低於17°C時，會無法使用遙控器啟動冷氣功能。在此情形下，您可以使用手動控制按鈕測試冷氣功能。

1. 抬起室內機的前面板，然後上舉直到聽到它卡在適當位置。
2. 手動控制按鈕位於設備右手側的。請按壓兩次選擇冷氣功能。
3. 正常執行測試運行。

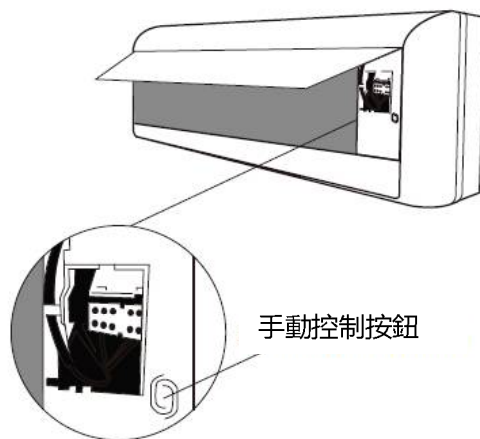

● 特別聲明

1. 以上資料已經過核對；如有任何印刷錯誤或內容方面的誤解，本公司將保留解釋權。
2. 本產品若有技術方面的改進，新版的操作說明中將會加入有關資料，恕不另行通知。產品外觀及顏色以冷氣機實物為準。
3. 本公司可應要求通過電子郵件發送電子版的用戶指南，請致電信興電工工程有限公司熱線電話2861 2767。

● 售後服務

保修期為購買日起計一年。如產品損毀屬正常使用下發生者，本公司可提供免費維修服務。請出示正式收據及蓋有銷售點/換購中心印章的保修證，以享用免費維修服務。如有查詢，請致電信興電器服務中心有限公司熱線電話2406 5666。

如發生以下任何情況，請立即關閉電源並聯絡信興電器服務中心有限公司。

- 斷路器經常跳掣或保險絲常被燒斷。
- 水或異物意外進入冷氣機內。
- 冷氣機操作時發出異常聲音。

信興電工工程有限公司

SHUN HING ELECTRIC WORKS & ENGINEERING CO., LTD

辦公室: 香港九龍尖沙咀東部麼地道 67 號半島中心 9 樓

OFFICE: 9/F, PENINSULA CENTRE, 67 MODY ROAD, TSIMSHATSUI EAST,
KOWLOON, HONG KONG

電話 TEL: (852) 2861 2767

傳真 FAX: (852) 2865 6706

網址 WEBSITE: www.rasonic.com

電郵 EMAIL: shew@shunhinggroup.com

保養及維修 MAINTENANCE AND REPAIR SERVICE

信興電器服務中心有限公司

SHUN HING ELECTRIC SERVICE CENTRE LTD.

辦公室: 香港新界葵涌勝耀街2號信興中心11樓

OFFICE: 11TH FLOOR, SHUN HING CENTRE, 2 SHING YIU STREET, KWAI CHUNG, NEW
TERRITORIES, HONG KONG

電話 TEL: (852) 2406 5666

傳真 FAX: (852) 2408 0316

網址 WEBSITE: www.shesc.com

消耗品/附件銷售熱線 CONSUMABLES/ ACCESSORIES SALES HOTLINE

電話 TEL: (852) 2406 5666

客戶服務中心 CUSTOMER SERVICE CENTRES

香港新界葵涌勝耀街2號信興中心1樓

1ST FLOOR, SHUN HING CENTRE, 2 SHING YIU STREET, KWAI CHUNG, NEW
TERRITORIES, HONG KONG

電話 TEL: (852) 2406 5439

傳真 FAX: (852) 2408 1389

澳門慕拉士大馬路193-199號南嶺工業大廈5樓I座

AVENIDA DE VENCESLAU DE MORAIS, NO. 193-199, 5 ANDAR-I, EDF. INDUSTRIAL
NAM LENG, MACAU

電話 TEL: (853) 2836 2928

傳真 FAX: (853) 2833 6405

有關最新之客戶服務中心資訊, 請參閱信興服務中心網址: www.shesc.com或致電維修服務熱線查詢。

For the latest information of customer service centres, please visit www.shesc.com or call us at our hotline.



R410A INVERTER COOLING
SPLIT-TYPE ROOM AIR CONDITIONER

OPERATION Manual & Installation Manual

Indoor Model:

RS-S9KI
RS-S12KI
RS-S18KI

Outdoor Model:

RU-S9KI
RU-S12KI
RU-S18KI



IMPORTANT NOTE:

Read this manual carefully before installing or operating your new air conditioning unit. Make sure to save this manual for future reference.

Table of Contents

Safety Precautions	03
---------------------------------	-----------

Owner's Manual

Unit Specifications and Features.....	07
1. Indoor unit display.....	07
2. Operating temperature.....	08
3. Other features	09
4. Setting angle of airflow.....	10
5. Manual operation (without Remote).....	10
Care and Maintenance.....	11
Troubleshooting.....	13

Installation Manual

Accessories.....	16
Installation Summary - Indoor Unit	17
Unit Parts.....	18
Indoor Unit Installation.....	19
1. Select installation location.....	19
2. Attach mounting plate to wall.....	19
3. Drill wall hole for connective piping.....	20
4. Prepare refrigerant piping.....	21
5. Connect drain hose.....	21
6. Connect signal and power cables.....	22
7. Wrap piping and cables.....	23
8. Mount indoor unit.....	24
Outdoor Unit Installation.....	25
1. Select installation location.....	25
2. Install drain joint.....	26
3. Anchor outdoor unit.....	26
4. Connect signal and power cables.....	28
Refrigerant Piping Connection.....	29
A. Note on Pipe Length.....	29
B. Connection Instructions –Refrigerant Piping.....	29
1. Cut pipe.....	29
2. Remove burrs.....	30
3. Flare pipe ends.....	30
4. Connect pipes.....	30
Air Evacuation.....	32
1. Evacuation Instructions.....	32
2. Note on Adding Refrigerant.....	33
Electrical and Gas Leak Checks.....	34
Test Run.....	35

Safety Precautions

Read Safety Precautions Before Operation and Installation

Incorrect installation due to ignoring instructions can cause serious damage or injury. The seriousness of potential damage or injuries is classified as either a **WARNING** or **CAUTION**.



WARNING

This symbol indicates the possibility of personnel injury or loss of life.



CAUTION

This symbol indicates the possibility of property damage or serious consequences.



WARNING

This appliance can be used by children aged from 8 years and above and persons with reduced physical, sensory or mental capabilities or lack of experience and knowledge if they have been given supervision or instruction concerning use of the appliance in a safe way and understand the hazards involved. Children shall not play with the appliance. Cleaning and user maintenance shall not be made by children without supervision (European Union countries).

This appliance is not intended for use by persons (including children) with reduced physical, sensory or mental capabilities, or lack of experience and knowledge, unless they have been given supervision or instruction concerning use of the appliance by a person responsible for their safety. Children should be supervised to ensure that they do not play with the appliance.



WARNINGS FOR PRODUCT USE

- If an abnormal situation arises (like a burning smell), immediately turn off the unit and disconnect the power. Call your dealer for instructions to avoid electric shock, fire or injury.
- **Do not** insert fingers, rods or other objects into the air inlet or outlet. This may cause injury, since the fan may be rotating at high speeds.
- **Do not** use flammable sprays such as hair spray, lacquer or paint near the unit. This may cause fire or combustion.
- **Do not** operate the air conditioner in places near or around combustible gases. Emitted gas may collect around the unit and cause explosion.
- **Do not** operate your air conditioner in a wet room such as a bathroom or laundry room. Too much exposure to water can cause electrical components to short circuit.
- **Do not** expose your body directly to cool air for a prolonged period of time.
- **Do not** allow children to play with the air conditioner. Children must be supervised around the unit at all times.
- If the air conditioner is used together with burners or other heating devices, thoroughly ventilate the room to avoid oxygen deficiency.
- In certain functional environments, such as kitchens, server rooms, etc., the use of specially designed air-conditioning units is highly recommended.

CLEANING AND MAINTENANCE WARNINGS

- Turn off the device and disconnect the power before cleaning. Failure to do so can cause electrical shock.
- **Do not** clean the air conditioner with excessive amounts of water.
- **Do not** clean the air conditioner with combustible cleaning agents. Combustible cleaning agents can cause fire or deformation.

 **CAUTION**

- Turn off the air conditioner and disconnect the power if you are not going to use it for a long time.
- Turn off and unplug the unit during storms.
- Make sure that water condensation can drain unhindered from the unit.
- **Do not** operate the air conditioner with wet hands. This may cause electric shock.
- **Do not** use device for any other purpose than its intended use.
- **Do not** climb onto or place objects on top of the outdoor unit.
- **Do not** allow the air conditioner to operate for long periods of time with doors or windows open, or if the humidity is very high.

 **ELECTRICAL WARNINGS**

- Only use the specified power cord. If the power cord is damaged, it must be replaced by the manufacturer, its service agent or similarly qualified persons in order to avoid a hazard.
- Keep power plug clean. Remove any dust or grime that accumulates on or around the plug. Dirty plugs can cause fire or electric shock.
- **Do not** pull power cord to unplug unit. Hold the plug firmly and pull it from the outlet. Pulling directly on the cord can damage it, which can lead to fire or electric shock.
- **Do not** modify the length of the power supply cord or use an extension cord to power the unit.
- **Do not** share the electrical outlet with other appliances. Improper or insufficient power supply can cause fire or electrical shock.
- The product must be properly grounded at the time of installation, or electrical shock may occur.
- For all electrical work, follow all local and national wiring standards, regulations, and the Installation Manual. Connect cables tightly, and clamp them securely to prevent external forces from damaging the terminal. Improper electrical connections can overheat and cause fire, and may also cause shock. All electrical connections must be made according to the Electrical Connection Diagram located on the panels of the indoor and outdoor units.
- All wiring must be properly arranged to ensure that the control board cover can close properly. If the control board cover is not closed properly, it can lead to corrosion and cause the connection points on the terminal to heat up, catch fire, or cause electrical shock.
- If connecting power to fixed wiring, an all-pole disconnection device which has at least 3mm clearances in all poles, and have a leakage current that may exceed 10mA, the residual current device(RCD) having a rated residual operating current not exceeding 30mA, and disconnection must be incorporated in the fixed wiring in accordance with the wiring rules.

TAKE NOTE OF FUSE SPECIFICATIONS

The air conditioner's circuit board (PCB) is designed with a fuse to provide overcurrent protection. The specifications of the fuse are printed on the circuit board ,such as :

T3.15A/250VAC, T5A/250VAC, T3.15A/250VAC, T5A/250VAC, T20A/250VAC, T30A/250VAC,etc.

NOTE: For the units using R32 or R290 refrigerant , only the blast-proof ceramic fuse can be used.

WARNINGS FOR PRODUCT INSTALLATION

1. Installation must be performed by an authorized dealer or specialist. Defective installation can cause water leakage, electrical shock, or fire.
2. Installation must be performed according to the installation instructions. Improper installation can cause water leakage, electrical shock, or fire.
3. Contact an authorized service technician for repair or maintenance of this unit. This appliance shall be installed in accordance with national wiring regulations.
4. Only use the included accessories, parts, and specified parts for installation. Using non-standard parts can cause water leakage, electrical shock, fire, and can cause the unit to fail.
5. Install the unit in a firm location that can support the unit's weight. If the chosen location cannot support the unit's weight, or the installation is not done properly, the unit may drop and cause serious injury and damage.
6. Install drainage piping according to the instructions in this manual. Improper drainage may cause water damage to your home and property.
7. For units that have an auxiliary electric heater, **do not** install the unit within 1 meter (3 feet) of any combustible materials.
8. **Do not** install the unit in a location that may be exposed to combustible gas leaks. If combustible gas accumulates around the unit, it may cause fire.
9. Do not turn on the power until all work has been completed.
10. When moving or relocating the air conditioner, consult authorized service technicians for disconnection and reinstallation of the unit.
11. How to install the appliance, please read the information for details in "indoor unit installation" and "outdoor unit installation" sections .

Note about Fluorinated Gasses(Not applicable to the unit using R290 Refrigerant)

1. This air-conditioning unit contains fluorinated greenhouse gasses. For specific information on the type of gas and the amount, please refer to the relevant label on the unit itself or the "Owner's Manual - Product Fiche " in the packaging of the outdoor unit. (European Union products only).
2. Installation, service, maintenance and repair of this unit must be performed by a certified technician.
3. Product uninstallation and recycling must be performed by a certified technician.
4. For equipment that contains fluorinated greenhouse gases in quantities of 5 tonnes of CO₂ equivalent or more, but of less than 50 tonnes of CO₂ equivalent, If the system has a leak-detection system installed, it must be checked for leaks at least every 24 months.
5. When the unit is checked for leaks, proper record-keeping of all checks is strongly recommended.

WARNING for Using R32/R290 Refrigerant

- When flammable refrigerant are employed, appliance shall be stored in a well -ventilated area where the room size corresponds to the room area as specific for operation.
For R32 frigerant models:
Appliance shall be installed, operated and stored in a room with a floor area larger than 4m².
For R290 refrigerant models, appliance shall be installed, operated and stored in a room with a floor area larger than:
 - <=9000Btu/h units: 13m²
 - >9000Btu/h and <=12000Btu/h units: 17m²
 - >12000Btu/h and <=18000Btu/h units: 26m²
 - >18000Btu/h and <=24000Btu/h units: 35m²
- Reusable mechanical connectors and flared joints are not allowed indoors. (EN Standard Requirements).
- Mechanical connectors used indoors shall have a rate of not more than 3g/year at 25% of the maximum allowable pressure. When mechanical connectors are reused indoors, sealing parts shall be renewed. When flared joints are reused indoors, the flare part shall be re-fabricated. (UL Standard Requirements)
- When mechanical connectors are reused indoors, sealing parts shall be renewed. When flared joints are reused indoors, the flare part shall be re-fabricated. (IEC Standard Requirements)
- Mechanical connectors used indoors shall comply with ISO 14903.

European Disposal Guidelines

This marking shown on the product or its literature, indicates that waste electrical and eletrical equipment should not be mixed with general household waste.

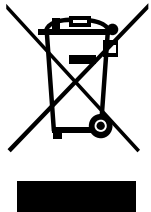

Correct Disposal of This Product (Waste Electrical & Electronic Equipment)

This appliance contains refrigerant and other potentially hazardous materials. When disposing of this appliance, the law requires special collection and treatment. **Do not** dispose of this product as household waste or unsorted municipal waste.

When disposing of this appliance, you have the following options:

- Dispose of the appliance at designated municipal electronic waste collection facility.
- When buying a new appliance, the retailer will take back the old appliance free of charge.
- The manufacturer will take back the old appliance free of charge.
- Sell the appliance to certified scrap metal dealers.

Special notice

Disposing of this appliance in the forest or other natural surroundings endangers your health and is bad for the environment. Hazardous substances may leak into the ground water and enter the food chain.

Unit Specifications and Features

Indoor unit display

NOTE: Different models have different front panels and display windows. Not all the display codes describing below are available for the air conditioner you purchased. Please check the indoor display window of the unit you purchased.

Illustrations in this manual are for explanatory purposes. The actual shape of your indoor unit may be slightly different. The actual shape shall prevail.

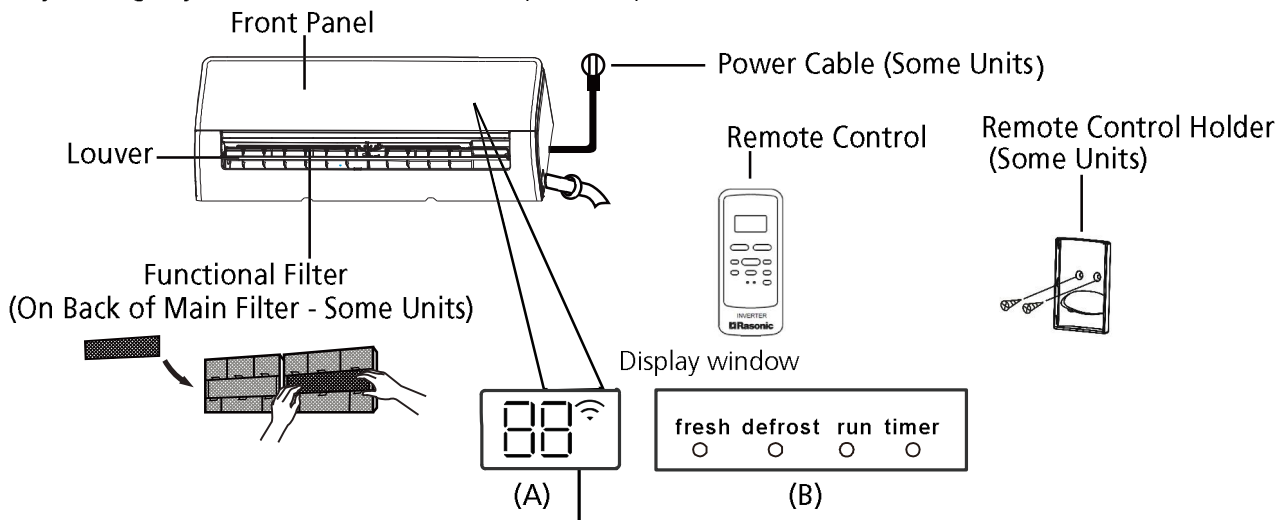



"fresh " when Fresh feature is activated(some units)

"defrost" when defrost feature is activated.

"run " when the unit is on.

"timer " when TIMER is set.

"  " when Wireless Control feature is activated(some units)

"  " Displays temperature, operation feature and error codes:

"  " for 3 seconds when:

- TIMER ON is set (if the unit is OFF, "  " remains on when TIMER ON is set)
- FRESH, SWING, TURBO, ECO, or SILENCE feature is turned on

"  " for 3 seconds when:

- TIMER OFF is set
- FRESH, SWING, TURBO, ECO, or SILENCE feature is turned off

"  " when defrosting

"  " when Active Clean feature is turned on

Display Code Meanings

Operating temperature

When your air conditioner is used outside of the following temperature ranges, certain safety protection features may activate and cause the unit to disable.

Inverter Split Type

	COOL mode	DRY mode
Room Temperature	16°C - 32°C (60°F - 90°F)	10°C - 32°C (50°F - 90°F)
Outdoor Temperature	0°C - 50°C (32°F - 122°F)	0°C - 50°C (32°F - 122°F)

FOR OUTDOOR UNITS WITH AUXILIARY ELECTRIC HEATER

When outside temperature is below 0°C (32°F), we strongly recommend keeping the unit plugged in at all time to ensure smooth ongoing performance.

NOTE: Room relative humidity less than 80%. If the air conditioner operates in excess of this figure, the surface of the air conditioner may attract condensation. Please sets the vertical air flow louver to its maximum angle (vertically to the floor), and set HIGH fan mode.

To further optimize the performance of your unit, do the following:

- Keep doors and windows closed.
- Limit energy usage by using TIMER ON and TIMER OFF functions.
- Do not block air inlets or outlets.
- Regularly inspect and clean air filters.

Other Features

- **Auto-Restart**

If the unit loses power, it will automatically restart with the prior settings once power has been restored.

- **Anti-mildew (not applicable)**

When turning off the unit from COOL, AUTO (COOL), or DRY modes, the air conditioner will continue operate at very low power to dry up condensed water and prevent mildew growth.

- **Wireless Control (not applicable)**

Wireless control allows you to control your air conditioner using your mobile phone and a wireless connection.

For the USB device access, replacement, maintenance operations must be carried out by professional staff.

- **Louver Angle Memory**

When turning on your unit, the louver will automatically resume its former angle.

- **Active Clean function**

- The Active Clean Technology washes away dust when it adheres to the heat exchanger by automatically freezing and then rapidly thawing the frost. A "pi-pi" sound will be heard.
- The Active clean operation is used to produce more condensed water to improve the cleaning effect, and the cold air will blow out. After cleaning, the internal wind wheel then keeps operating with hot air to blow-dry the evaporator, thus keeping the inside clean.

-- When this function is turned on, the indoor unit display window appears "CL " , after 20 to 130 minutes, the unit will turn off automatically and cancel Active Clean function.

-- For some units, the system will start high-temperature cleaning process, and the temperature of air outlet is very high. Please keep away from it. And this would lead to the rising of the room temperature .

- **Defrost Function**

When the air conditioner detects that the condenser is frosted, it will automatically start the defrosting function, and it cannot be stopped until the defrosting is completed.

- **Breeze Away (not applicable)**

This feature avoids direct air flow blowing on the body and make you feel including in silky coolness.

- **Refrigerant Leakage Detection**

The indoor unit will automatically display "ELOC" or flash LEDS (model dependent) when it detects refrigerant leakage.

- **Sleep Operation**

The SLEEP function is used to decrease energy use while you sleep (and don't need the same temperature settings to stay comfortable). This function can only be activated via remote control. And the Sleep function is not available in FAN or DRY mode.

Press the **SLEEP** button when you are ready to go to sleep. When in COOL mode, the unit will increase the temperature by 1°C (2°F) after 1 hour, and will increase an additional 1°C (2°F) after another hour. When in HEAT mode, the unit will decrease the temperature by 1°C (2°F) after 1 hour, and will decrease an additional 1°C (2°F) after another hour.(Heat mode is not applicable for cooling only model)

The sleep feature will stop after 8 hours and the system will keep running with final situation.

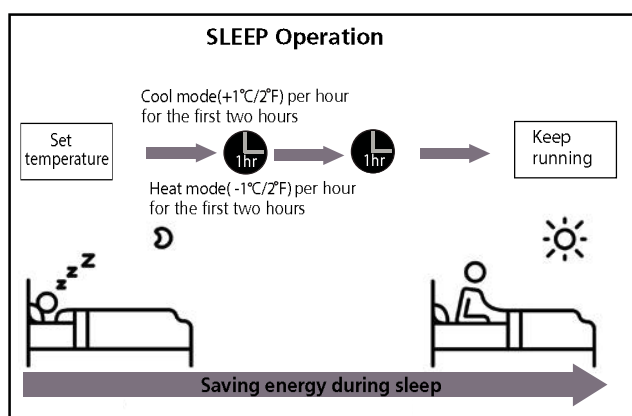

• Setting Angle of Air Flow

Setting vertical angle of air flow

While the unit is on, use the **SWING/DIRECT** button on remote control to set the direction (vertical angle) of airflow. Please refer to the Remote Control Manual for details.

NOTE ON LOUVER ANGLES

When using COOL or DRY mode, do not set louver at too vertical an angle for long periods of time. This can cause water to condense on the louver blade, which will drop on your floor or furnishings.

When using COOL or HEAT mode (Heat mode is not applicable for cooling only model), setting the louver at too small an angle can reduce the performance of the unit due to restricted air flow.

NOTE: According to the relative standards requirement, please sets the vertical air flow louver to its maximum angle under heating capacity test.

Setting horizontal angle of air flow

The horizontal angle of the airflow must be set manually. Grip the deflector rod (See **Fig.B**) and manually adjust it to your preferred direction.

Manual Operation(without remote)

⚠ CAUTION

The manual button is intended for testing purposes and emergency operation only. Please do not use this function unless the remote control is lost and it is absolutely necessary. To restore regular operation, use the remote control to activate the unit. Unit must be turned off before manual operation.

To operate your unit manually:

1. Open the front panel of the indoor unit.
2. Locate the **MANUAL CONTROL button** on the right-hand side of the unit.
3. Press the **MANUAL CONTROL button** one time to activate FORCED AUTO mode.
4. Press the **MANUAL CONTROL button** again to activate FORCED COOLING mode.
5. Press the **MANUAL CONTROL button** a third time to turn the unit off.
6. Close the front panel.

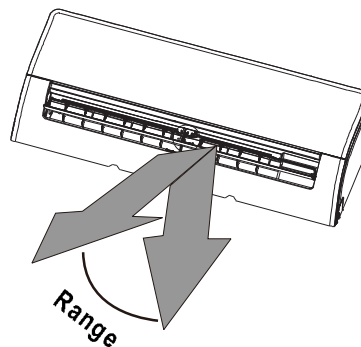

NOTE: Do not move louver by hand. This will cause the louver to become out of sync. If this occurs, turn off the unit and unplug it for a few seconds, then restart the unit. This will reset the louver.

Fig. A

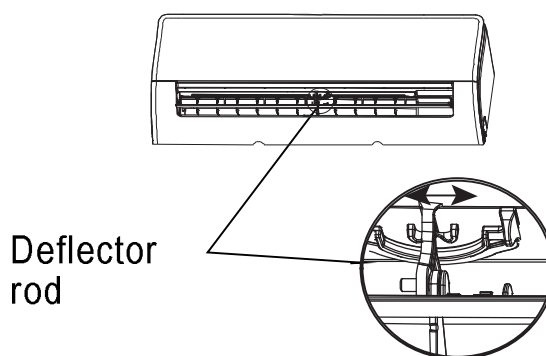
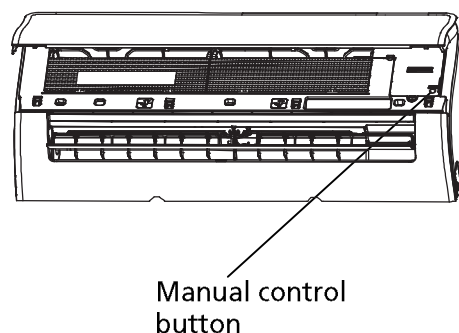

Fig. B



⚠ CAUTION

Do not put your fingers in or near the blower and suction side of the unit. The high-speed fan inside the unit may cause injury.

Care and Maintenance

Cleaning Your Indoor Unit



BEFORE CLEANING OR MAINTENANCE

ALWAYS TURN OFF YOUR AIR CONDITIONER SYSTEM AND DISCONNECT ITS POWER SUPPLY BEFORE CLEANING OR MAINTENANCE.



CAUTION

Only use a soft, dry cloth to wipe the unit clean. If the unit is especially dirty, you can use a cloth soaked in warm water to wipe it clean.

- **Do not** use chemicals or chemically treated cloths to clean the unit
- **Do not** use benzene, paint thinner, polishing powder or other solvents to clean the unit. They can cause the plastic surface to crack or deform.
- **Do not** use water hotter than 40°C (104°F) to clean the front panel. This can cause the panel to deform or become discolored.

Cleaning Your Air Filter

A clogged air conditioner can reduce the cooling efficiency of your unit, and can also be bad for your health. Make sure to clean the filter once every two weeks.

1. Lift the front panel of the indoor unit.
2. First press the tab on the end of filter to loosen the buckle, lift it up, then pull it towards yourself.
3. Now pull the filter out.
4. If your filter has a small air freshening filter, unclip it from the larger filter. Clean this air freshening filter with a hand-held vacuum.
5. Clean the large air filter with warm, soapy water. Be sure to use a mild detergent.

6. Rinse the filter with fresh water, then shake off excess water.
7. Dry it in a cool, dry place, and refrain from exposing it to direct sunlight.
8. When dry, re-clip the air freshening filter to the larger filter, then slide it back into the indoor unit.
9. Close the front panel of the indoor unit.

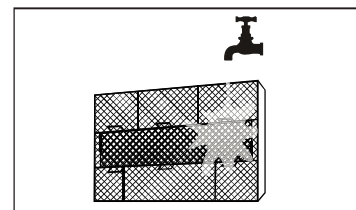
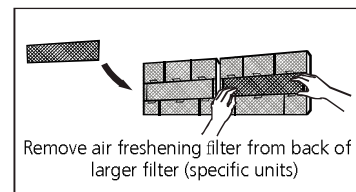
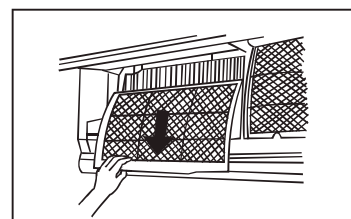
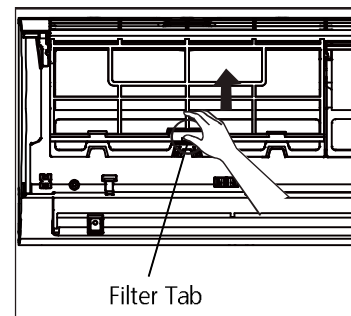

CAUTION

Do not touch air freshening (Plasma) filter for at least 10 minutes after turning off the unit.

CAUTION

- Before changing the filter or cleaning, turn off the unit and disconnect its power supply.
- When removing filter, do not touch metal parts in the unit. The sharp metal edges can cut you.
- Do not use water to clean the inside of the indoor unit. This can destroy insulation and cause electrical shock.
- Do not expose filter to direct sunlight when drying. This can shrink the filter.

Air Filter Reminders (Optional)

Air Filter Cleaning Reminder

After 240 hours of use, the display window on the indoor unit will flash "CL." This is a reminder to clean your filter. After 15 seconds, the unit will revert to its previous display.

To reset the reminder, press the **LED** button on your remote control 4 times, or press the **MANUAL CONTROL** button 3 times. If you don't reset the reminder, the "CL" indicator will flash again when you restart the unit.

Air Filter Replacement Reminder

After 2,880 hours of use, the display window on the indoor unit will flash "nF." This is a reminder to replace your filter. After 15 seconds, the unit will revert to its previous display.

To reset the reminder, press the **LED** button on your remote control 4 times, or press the **MANUAL CONTROL** button 3 times. If you don't reset the reminder, the "nF" indicator will flash again when you restart the unit.

CAUTION

- Any maintenance and cleaning of outdoor unit should be performed by an authorized dealer or a licensed service provider.
- Any unit repairs should be performed by an authorized dealer or a licensed service provider.

Maintenance – Long Periods of Non-Use

If you plan not to use your air conditioner for an extended period of time, do the following:

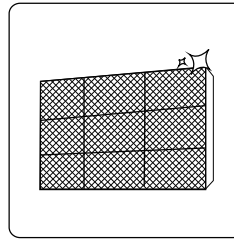

Clean all filters

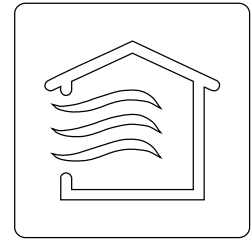

Turn on FAN function until unit dries out completely

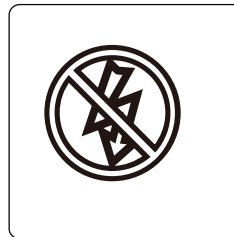

Turn off the unit and disconnect the power

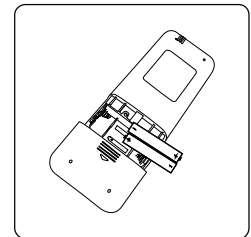

Remove batteries from remote control

Maintenance – Pre-Season Inspection

After long periods of non-use, or before periods of frequent use, do the following:

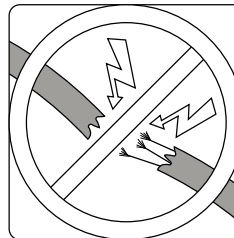

Check for damaged wires

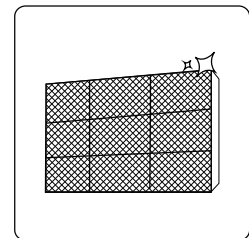

Clean all filters



Check for leaks

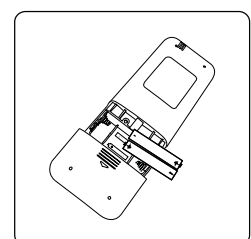

Replace batteries

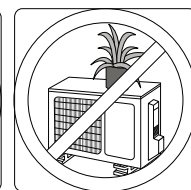
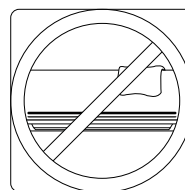

Make sure nothing is blocking all air inlets and outlets

Troubleshooting

SAFETY PRECAUTIONS

If ANY of the following conditions occurs, turn off your unit immediately!

- The power cord is damaged or abnormally warm
- You smell a burning odor
- The unit emits loud or abnormal sounds
- A power fuse blows or the circuit breaker frequently trips
- Water or other objects fall into or out of the unit

DO NOT ATTEMPT TO FIX THESE YOURSELF! CONTACT AN AUTHORIZED SERVICE PROVIDER IMMEDIATELY!

Common Issues

The following problems are not a malfunction and in most situations will not require repairs.

Issue	Possible Causes
Unit does not turn on when pressing ON/OFF button	The Unit has a 3-minute protection feature that prevents the unit from overloading. The unit cannot be restarted within three minutes of being turned off.
The unit changes from COOL mode to FAN	The unit may change its setting to prevent frost from forming on the unit. Once the temperature increases, the unit will start operating in the previously selected mode again.
	The set temperature has been reached, at which point the unit turns off the compressor. The unit will continue operating when the temperature fluctuates again.
The indoor unit emits white mist	In humid regions, a large temperature difference between the room's air and the conditioned air can cause white mist.
Both the indoor and outdoor units emit white mist	When the unit restarts in HEAT mode after defrosting, white mist may be emitted due to moisture generated from the defrosting process. (Heat mode is not applicable for cooling only model)
The indoor unit makes noises	A rushing air sound may occur when the louver resets its position.
	A squeaking sound may occur after running the unit in HEAT mode due to expansion and contraction of the unit's plastic parts.
Both the indoor unit and outdoor unit make noises	Low hissing sound during operation: This is normal and is caused by refrigerant gas flowing through both indoor and outdoor units.
	Low hissing sound when the system starts, has just stopped running, or is defrosting: This noise is normal and is caused by the refrigerant gas stopping or changing direction.
	Squeaking sound: Normal expansion and contraction of plastic and metal parts caused by temperature changes during operation can cause squeaking noises.

Issue	Possible Causes
The outdoor unit makes noises	The unit will make different sounds based on its current operating mode.
Dust is emitted from either the indoor or outdoor unit	The unit may accumulate dust during extended periods of non-use, which will be emitted when the unit is turned on. This can be mitigated by covering the unit during long periods of inactivity.
The unit emits a bad odor	The unit may absorb odors from the environment (such as furniture, cooking, cigarettes, etc.) which will be emitted during operations.
	The unit's filters have become moldy and should be cleaned.
The fan of the outdoor unit does not operate	During operation, the fan speed is controlled to optimize product operation.
Operation is erratic, unpredictable, or unit is unresponsive	Interference from cell phone towers and remote boosters may cause the unit to malfunction. In this case, try the following: <ul style="list-style-type: none"> • Disconnect the power, then reconnect. • Press ON/OFF button on remote control to restart operation.

NOTE: If problem persists, contact a local dealer or your nearest customer service center. Provide them with a detailed description of the unit malfunction as well as your model number and serial number.

Troubleshooting

When troubles occur, please check the following points before contacting a repair company.











Problem	Possible Causes	Solution
Poor Cooling Performance	Temperature setting may be higher than ambient room temperature	Lower the temperature setting
	The heat exchanger on the indoor or outdoor unit is dirty	Clean the affected heat exchanger
	The air filter is dirty	Remove the filter and clean it according to instructions
	The air inlet or outlet of either unit is blocked	Turn the unit off, remove the obstruction and turn it back on
	Doors and windows are open	Make sure that all doors and windows are closed while operating the unit
	Excessive heat is generated by sunlight	Close windows and curtains during periods of high heat or bright sunshine
	Too many sources of heat in the room (people, computers, electronics, etc.)	Reduce amount of heat sources
	Low refrigerant due to leak or long-term use	Check for leaks, re-seal if necessary and top off refrigerant
SILENCE function is activated (optional function)	SILENCE function can lower product performance by reducing operating frequency. Turn off SILENCE function.	

Problem	Possible Causes	Solution
The unit is not working	Power failure	Wait for the power to be restored
	The power is turned off	Turn on the power
	The fuse is burned out	Replace the fuse
	Remote control batteries are dead	Replace batteries
	The Unit's 3-minute protection has been activated	Wait three minutes after restarting the unit
	Timer is activated	Turn timer off
The unit starts and stops frequently	There's too much or too little refrigerant in the system	Check for leaks and recharge the system with refrigerant.
	Incompressible gas or moisture has entered the system.	Evacuate and recharge the system with refrigerant
	The compressor is broken	Replace the compressor
	The voltage is too high or too low	Install a manostat to regulate the voltage
Poor heating performance	The outdoor temperature is extremely low	Use auxiliary heating device
	Cold air is entering through doors and windows	Make sure that all doors and windows are closed during use
	Low refrigerant due to leak or long-term use	Check for leaks, re-seal if necessary and top off refrigerant
Indicator lamps continue flashing	The unit may stop operation or continue to run safely. If the indicator lamps continue to flash or error codes appear, wait for about 10 minutes. The problem may resolve itself. If not, disconnect the power, then connect it again. Turn the unit on. If the problem persists, disconnect the power and contact Shun Hing Electric Service Centre Ltd.	
Error code appears and begins with the letters as the following in the window display of indoor unit:	<ul style="list-style-type: none"> • E(x), P(x), F(x) • EH(xx), EL(xx), EC(xx) • PH(xx), PL(xx), PC(xx) 	

NOTE: If your problem persists after performing the checks and diagnostics above, turn off your unit immediately and contact Shun Hing Electric Service Centre Ltd.

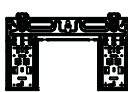
Accessories

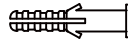
The air conditioning system comes with the following accessories. Use all of the installation parts and accessories to install the air conditioner. Improper installation may result in water leakage, electrical shock and fire, or cause the equipment to fail. The items are not included with the air conditioner must be purchased separately.

Name of Accessories	Q'ty(pc)	Shape	Name of Accessories	Q'ty(pc)	Shape
Manual	2-3		Remote controller	1	
Drain joint (for cooling & heating models)	1		Battery	2	
Seal (for cooling & heating models)	1		Remote controller holder(optional)	1	
Mounting plate	1		Fixing screw for remote controller holder(optional)	2	
Anchor	5~8 (depending on models)		Small Filter (Need to be installed on the back of main air filter by the authorized technician while installing the machine)	1~2 (depending on models)	
Mounting plate fixing screw	5~8 (depending on models)				

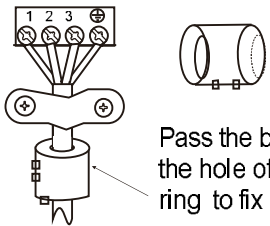
Connecting pipe assembly	Liquid side	Φ 6.35 (1/4in)	Parts you must purchase separately. Consult the dealer about the proper pipe size of the unit you purchased.
		Φ 9.52 (3/8in)	
	Gas side	Φ 9.52 (3/8in)	
		Φ 12.7 (1/2in)	
		Φ 16 (5/8in)	
		Φ 19 (3/4in)	
Magnetic ring and belt (if supplied, please refer to the wiring diagram to install it on the connective cable.)	 <p>Pass the belt through the hole of the Magnetic ring to fix it on the cable</p>	Varies by model	

Installation Summary - Indoor Unit

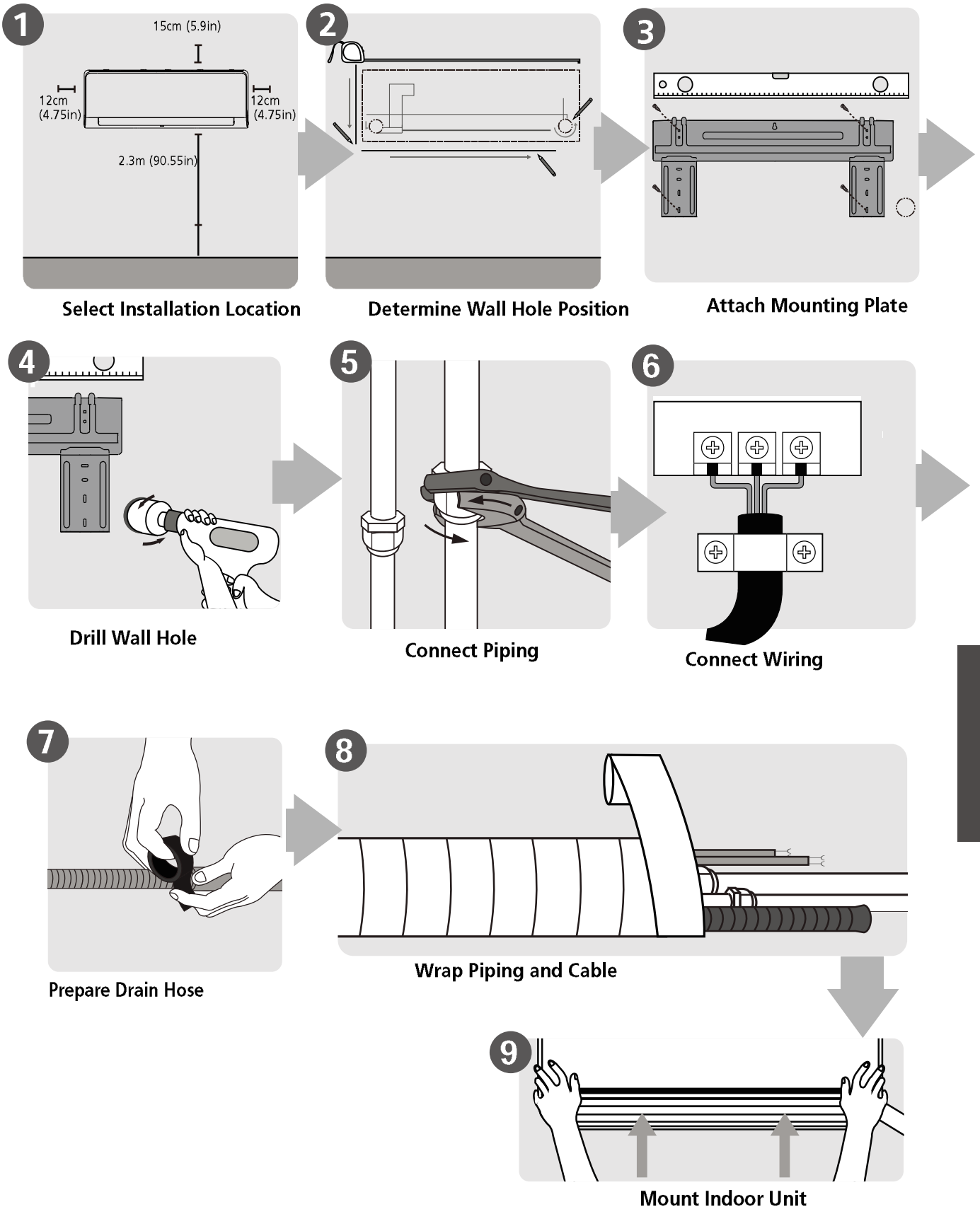

Installation Summary
-Indoor Unit

Unit Parts

NOTE: The installation must be performed in accordance with the requirement of local and national standards. The installation may be slightly different in different areas.

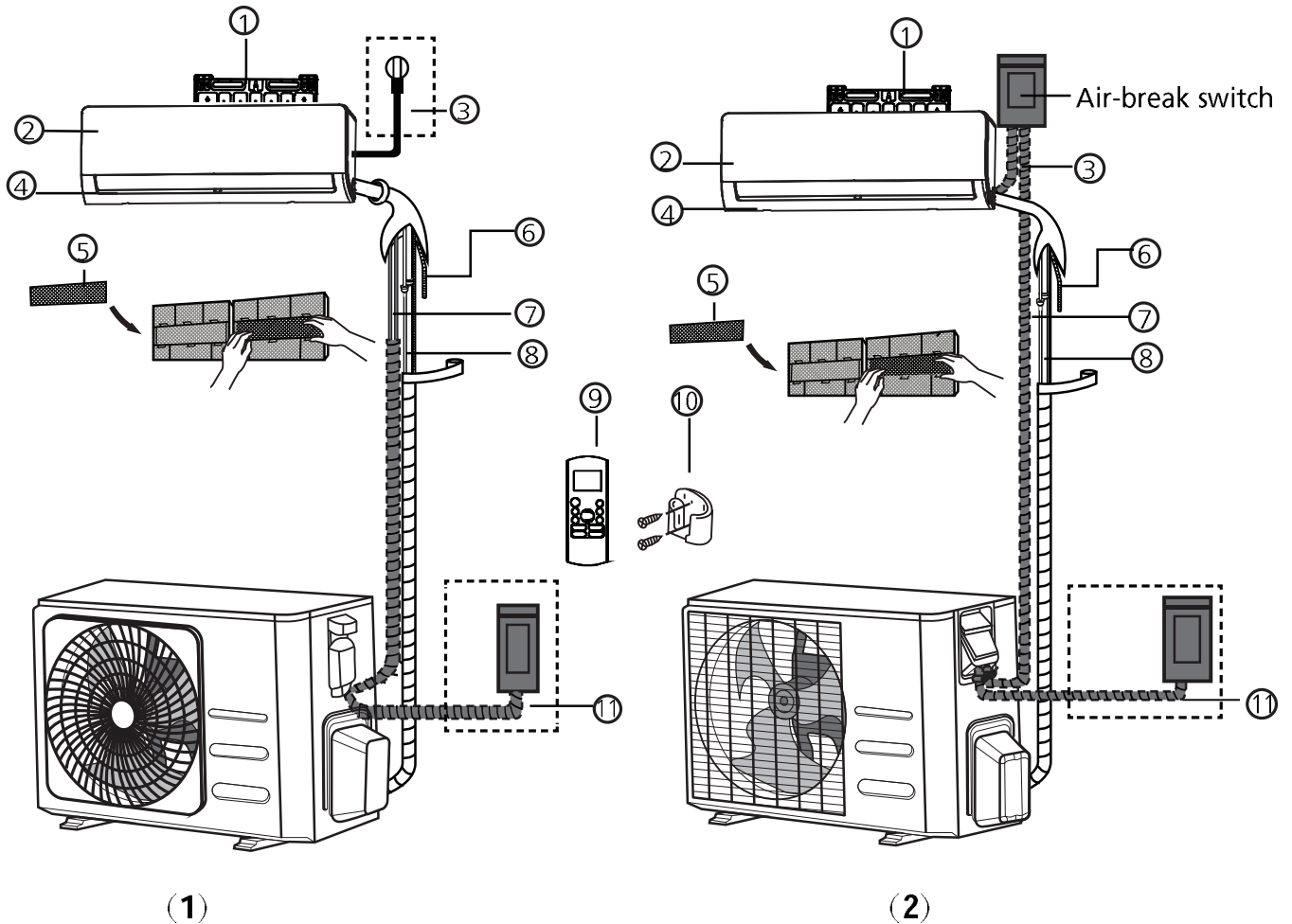

- | | | |
|---|---|---|
| ① Wall Mounting Plate | ⑤ Functional Filter (On Back of Main Filter - Some Units) | ⑨ Remote Controller |
| ② Front Panel | ⑥ Drainage Pipe | ⑩ Remote controller Holder (Some Units) |
| ③ Power Cable
(Supply with the specific model) | ⑦ Signal Cable | ⑪ Outdoor Unit Power Cable (Some Units) |
| ④ Louver | ⑧ Refrigerant Piping | |

NOTE ON ILLUSTRATIONS

Illustrations in this manual are for explanatory purposes. The actual shape of your indoor unit may be slightly different. The actual shape shall prevail.

Indoor Unit Installation

Installation Instructions – Indoor unit

PRIOR TO INSTALLATION

Before installing the indoor unit, refer to the label on the product box to make sure that the model number of the indoor unit matches the model number of the outdoor unit.

Step 1: Select installation location

Before installing the indoor unit, you must choose an appropriate location. The following are standards that will help you choose an appropriate location for the unit.

Proper installation locations meet the following standards:

- Good air circulation
- Convenient drainage
- Noise from the unit will not disturb other people
- Firm and solid—the location will not vibrate
- Strong enough to support the weight of the unit
- A location at least one meter from all other electrical devices (e.g., TV, radio, computer)

DO NOT install unit in the following locations:

- Near any source of heat, steam, or combustible gas
- Near flammable items such as curtains or clothing
- Near any obstacle that might block air circulation
- Near the doorway
- In a location subject to direct sunlight

NOTE ABOUT WALL HOLE:

If there is no fixed refrigerant piping:

While choosing a location, be aware that you should leave ample room for a wall hole (see **Drill wall hole for connective piping** step) for the signal cable and refrigerant piping that connect the indoor and outdoor units. The default position for all piping is the right side of the indoor unit (while facing the unit). However, the unit can accommodate piping to both the left and right.

Refer to the following diagram to ensure proper distance from walls and ceiling:

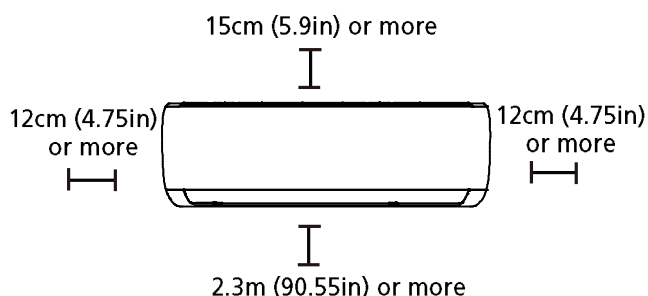

Step 2: Attach mounting plate to wall

The mounting plate is the device on which you will mount the indoor unit.

- Remove the screw that attaches the mounting plate to the back of the indoor unit.

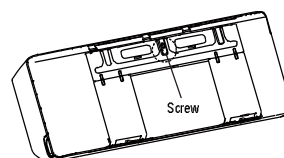

- Secure the mounting plate to the wall with the screws provided. Make sure that mounting plate is flat against the wall.

NOTE FOR CONCRETE OR BRICK WALLS:

If the wall is made of brick, concrete, or similar material, drill 5mm-diameter (0.2in-diameter) holes in the wall and insert the sleeve anchors provided. Then secure the mounting plate to the wall by tightening the screws directly into the clip anchors.

Step 3: Drill wall hole for connective piping

1. Determine the location of the wall hole based on the position of the mounting plate. Refer to **Mounting Plate Dimensions**.
2. Using a 65mm (2.5in) or 90mm(3.54in) (depending on models)core drill, drill a hole in the wall. Make sure that the hole is drilled at a slight downward angle, so that the outdoor end of the hole is lower than the indoor end by about 5mm to 7mm (0.2-0.275in). This will ensure proper water drainage.
3. Place the protective wall cuff in the hole. This protects the edges of the hole and will help seal it when you finish the installation process.

! CAUTION

When drilling the wall hole, make sure to avoid wires, plumbing, and other sensitive components.

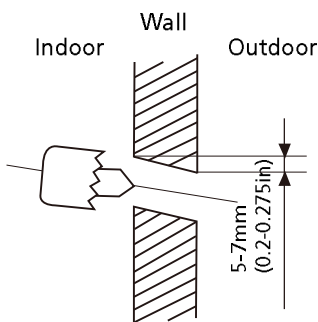

MOUNTING PLATE DIMENSIONS

Different models have different mounting plates. For the different customization requirements, the shape of the mounting plate and the dimensions of the indoor unit may be slightly different. See Type A and Type B for example:

Correct orientation of Mounting Plate

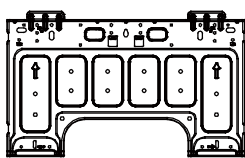
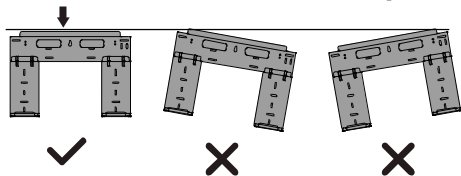

Type A

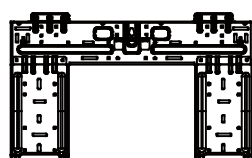

Type B

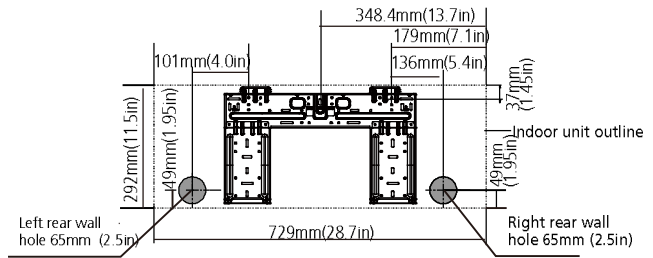

Model A

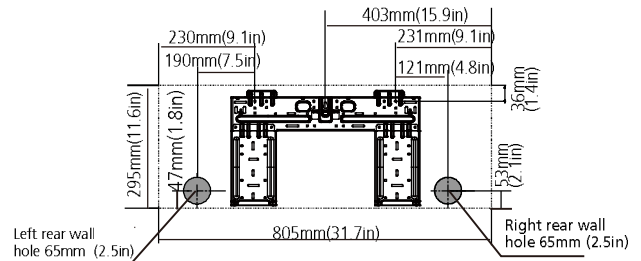

Model B

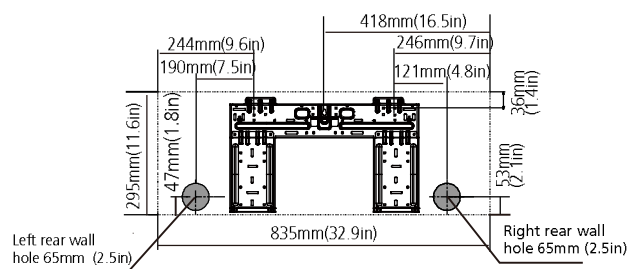

Model C

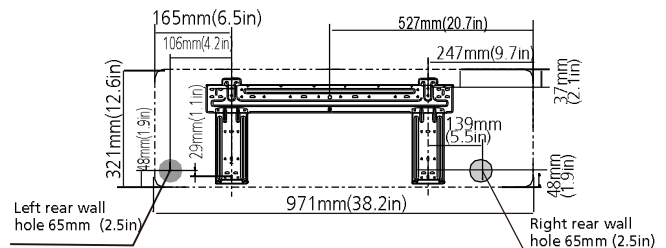

Model D

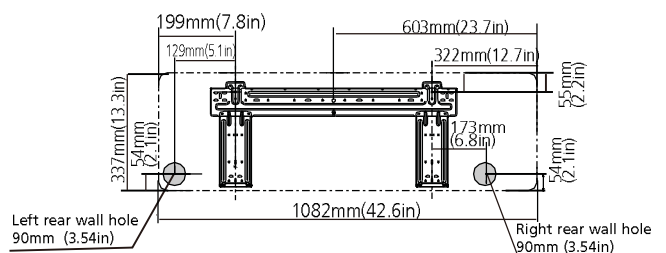

Model E

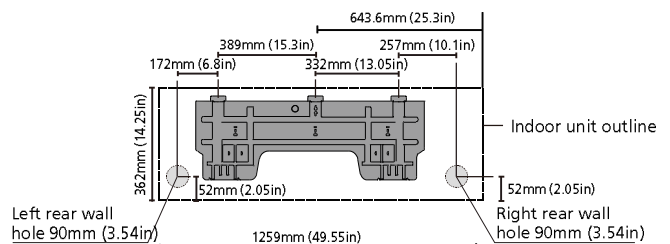

Model F

NOTE: When the gas side connective pipe is Φ 16mm(5/8in) or more, the wall hole should be 90mm(3.54in).

Step 4: Prepare refrigerant piping

The refrigerant piping is inside an insulating sleeve attached to the back of the unit. You must prepare the piping before passing it through the hole in the wall.

1. Based on the position of the wall hole relative to the mounting plate, choose the side from which the piping will exit the unit.
2. If the wall hole is behind the unit, keep the knock-out panel in place. If the wall hole is to the side of the indoor unit, remove the plastic knock-out panel from that side of the unit. This will create a slot through which your piping can exit the unit. Use needle nose pliers if the plastic panel is too difficult to remove by hand.

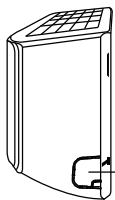

Knock-out Panel

3. If existing connective piping is already embedded in the wall, proceed directly to the **Connect Drain Hose** step. If there is no embedded piping, connect the indoor unit's refrigerant piping to the connective piping that will join the indoor and outdoor units. Refer to the **Refrigerant Piping Connection** section of this manual for detailed instructions.

NOTE ON PIPING ANGLE

Refrigerant piping can exit the indoor unit from four different angles: Left-hand side, Right-hand side, Left rear, Right rear.

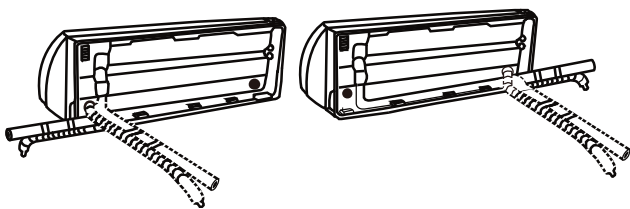

CAUTION

Be extremely careful not to dent or damage the piping while bending them away from the unit. Any dents in the piping will affect the unit's performance.

Step 5: Connect drain hose

By default, the drain hose is attached to the left-hand side of unit (when you're facing the back of the unit). However, it can also be attached to the right-hand side. To ensure proper drainage, attach the drain hose on the same side that your refrigerant piping exits the unit. Attach drain hose extension (purchased separately) to the end of drain hose.

- Wrap the connection point firmly with Teflon tape to ensure a good seal and to prevent leaks.
- For the portion of the drain hose that will remain indoors, wrap it with foam pipe insulation to prevent condensation.
- Remove the air filter and pour a small amount of water into the drain pan to make sure that water flows from the unit smoothly.

NOTE ON DRAIN HOSE PLACEMENT

Make sure to arrange the drain hose according to the following figures.

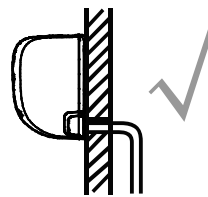

CORRECT

Make sure there are no kinks or dent in drain hose to ensure proper drainage.

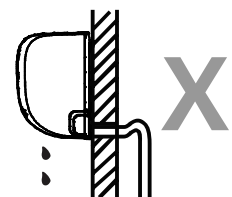

NOT CORRECT

Kinks in the drain hose will create water traps.

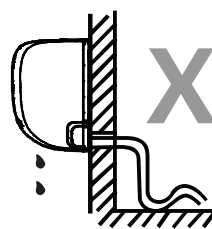

NOT CORRECT

Kinks in the drain hose will create water traps.

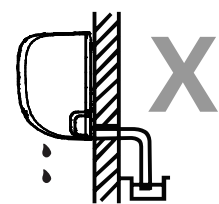

NOT CORRECT

Do not place the end of the drain hose in water or in containers that collect water. This will prevent proper drainage.

PLUG THE UNUSED DRAIN HOLE

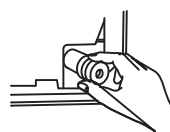

To prevent unwanted leaks you must plug the unused drain hole with the rubber plug provided.



BEFORE PERFORMING ANY ELECTRICAL WORK, READ THESE REGULATIONS

1. All wiring must comply with local and national electrical codes, regulations and must be installed by a licensed electrician.
2. All electrical connections must be made according to the Electrical Connection Diagram located on the panels of the indoor and outdoor units.
3. If there is a serious safety issue with the power supply, stop work immediately. Explain your reasoning to the client, and refuse to install the unit until the safety issue is properly resolved.
4. Power voltage should be within 90-110% of rated voltage. Insufficient power supply can cause malfunction, electrical shock, or fire.
5. If connecting power to fixed wiring, a surge protector and main power switch should be installed.
6. If connecting power to fixed wiring, a switch or circuit breaker that disconnects all poles and has a contact separation of at least 1/8in (3mm) must be incorporated in the fixed wiring. The qualified technician must use an approved circuit breaker or switch.
7. Only connect the unit to an individual branch circuit outlet. Do not connect another appliance to that outlet.
8. Make sure to properly ground the air conditioner.
9. Every wire must be firmly connected. Loose wiring can cause the terminal to overheat, resulting in product malfunction and possible fire.
10. Do not let wires touch or rest against refrigerant tubing, the compressor, or any moving parts within the unit.
11. If the unit has an auxiliary electric heater, it must be installed at least 1 meter (40in) away from any combustible materials.
12. To avoid getting an electric shock, never touch the electrical components soon after the power supply has been turned off. After turning off the power, always wait 10 minutes or more before you touch the electrical components.



WARNING

BEFORE PERFORMING ANY ELECTRICAL OR WIRING WORK, TURN OFF THE MAIN POWER TO THE SYSTEM.

Step 6: Connect signal and power cables

The signal cable enables communication between the indoor and outdoor units. You must first choose the right cable size before preparing it for connection.

Cable Types

- **Indoor Power Cable** (if applicable): H05VV-F or H05V2V2-F
- **Outdoor Power Cable:** H07RN-F or H05RN-F
- **Signal Cable:** H07RN-F

Minimum Cross-Sectional Area of Power and Signal Cables (For reference)

Rated Current of Appliance (A)	Nominal Cross-Sectional Area (mm ²)
> 3 and ≤ 6	0.75
> 6 and ≤ 10	1
> 10 and ≤ 16	1.5
> 16 and ≤ 25	2.5
> 25 and ≤ 32	4
> 32 and ≤ 40	6

CHOOSE THE RIGHT CABLE SIZE

The size of the power supply cable, signal cable, fuse, and switch needed is determined by the maximum current of the unit. The maximum current is indicated on the nameplate located on the side panel of the unit.



WARNING

ALL WIRING MUST BE PERFORMED STRICTLY IN ACCORDANCE WITH THE WIRING DIAGRAM LOCATED ON THE BACK OF THE INDOOR UNIT'S FRONT PANEL .

1. Open front panel of the indoor unit.
2. Using a screwdriver, open the wire box cover on the right side of the unit. This will reveal the terminal block.

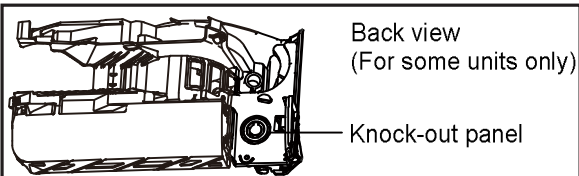
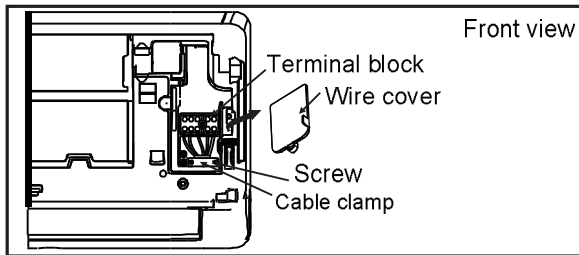

NOTE:

- For the units with conduit tube to connect the cable, remove the big plastic knock-out panel to create a slot through which the conduit tube can be installed.
- For the units with five-core cable, remove the middle small plastic knock-out panel to create a slot through which the cable can exit.
- Use needle nose pliers if the plastic panel is too difficult to remove by hand.

3. Unscrew the cable clamp below the terminal block and place it to the side.
4. Facing the back of the unit, remove the plastic panel on the bottom left-hand side.
5. Feed the signal wire through this slot, from the back of the unit to the front.
6. Facing the front of the unit, connect the wire according to the indoor unit's wiring diagram, connect the u-lug and firmly screw each wire to its corresponding terminal.

WARNING

DO NOT MIX UP LIVE AND NULL WIRES

This is dangerous, and can cause the air conditioning unit to malfunction.

7. After checking to make sure every connection is secure, use the cable clamp to fasten the signal cable to the unit. Screw the cable clamp down tightly.
8. Replace the wire cover on the front of the unit, and the plastic panel on the back.

NOTE ABOUT WIRING

THE WIRING CONNECTION PROCESS MAY DIFFER SLIGHTLY BETWEEN UNITS AND REGIONS.

Step 7: Wrap piping and cables

Before passing the piping, drain hose, and the signal cable through the wall hole, you must bundle them together to save space, protect them, and insulate them.

1. Bundle the drain hose, refrigerant pipes, and signal cable as shown below:

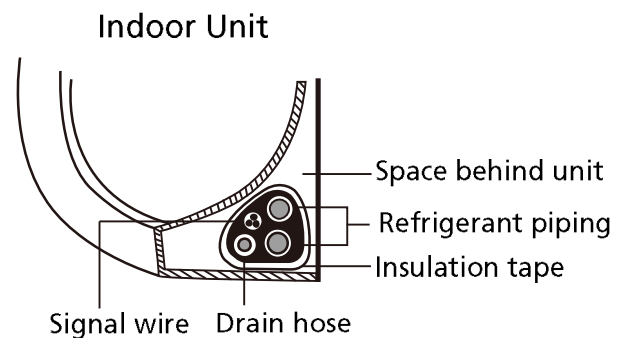

DRAIN HOSE MUST BE ON BOTTOM

Make sure that the drain hose is at the bottom of the bundle. Putting the drain hose at the top of the bundle can cause the drain pan to overflow, which can lead to fire or water damage.

DO NOT INTERTWINE SIGNAL CABLE WITH OTHER WIRES

While bundling these items together, do not intertwine or cross the signal cable with any other wiring.

2. Using adhesive vinyl tape, attach the drain hose to the underside of the refrigerant pipes.
3. Using insulation tape, wrap the signal wire, refrigerant pipes, and drain hose tightly together. Double-check that all items are bundled.

DO NOT WRAP ENDS OF PIPING

When wrapping the bundle, keep the ends of the piping unwrapped. You need to access them to test for leaks at the end of the installation process (refer to **Electrical Checks and Leak Checks** section of this manual).

Step 8: Mount indoor unit

If you installed new connective piping to the outdoor unit, do the following:

1. If you have already passed the refrigerant piping through the hole in the wall, proceed to Step 4.
2. Otherwise, double-check that the ends of the refrigerant pipes are sealed to prevent dirt or foreign materials from entering the pipes.
3. Slowly pass the wrapped bundle of refrigerant pipes, drain hose, and signal wire through the hole in the wall.
4. Hook the top of the indoor unit on the upper hook of the mounting plate.
5. Check that unit is hooked firmly on mounting by applying slight pressure to the left and right-hand sides of the unit. The unit should not jiggle or shift.
6. Using even pressure, push down on the bottom half of the unit. Keep pushing down until the unit snaps onto the hooks along the bottom of the mounting plate.
7. Again, check that the unit is firmly mounted by applying slight pressure to the left and the right-hand sides of the unit.

If refrigerant piping is already embedded in the wall, do the following:

1. Hook the top of the indoor unit on the upper hook of the mounting plate.
2. Use a bracket or wedge to prop up the unit, giving you enough room to connect the refrigerant piping, signal cable, and drain hose.

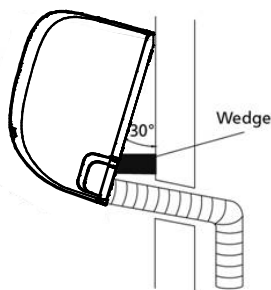

3. Connect drain hose and refrigerant piping (refer to **Refrigerant Piping Connection** section of this manual for instructions).
4. Keep pipe connection point exposed to perform the leak test (refer to **Electrical Checks and Leak Checks** section of this manual).
5. After the leak test, wrap the connection point with insulation tape.
6. Remove the bracket or wedge that is propping up the unit.
7. Using even pressure, push down on the bottom half of the unit. Keep pushing down until the unit snaps onto the hooks along the bottom of the mounting plate.

UNIT IS ADJUSTABLE

Keep in mind that the hooks on the mounting plate are smaller than the holes on the back of the unit. If you find that you don't have ample room to connect embedded pipes to the indoor unit, the unit can be adjusted left or right by about 30-50mm (1.18-1.96in), depending on the model.

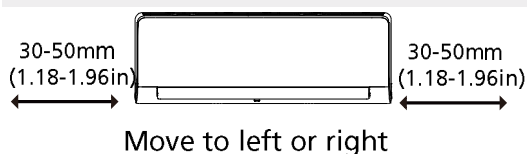

Outdoor Unit Installation

Install the unit by following local codes and regulations, there may be differ slightly between different regions.

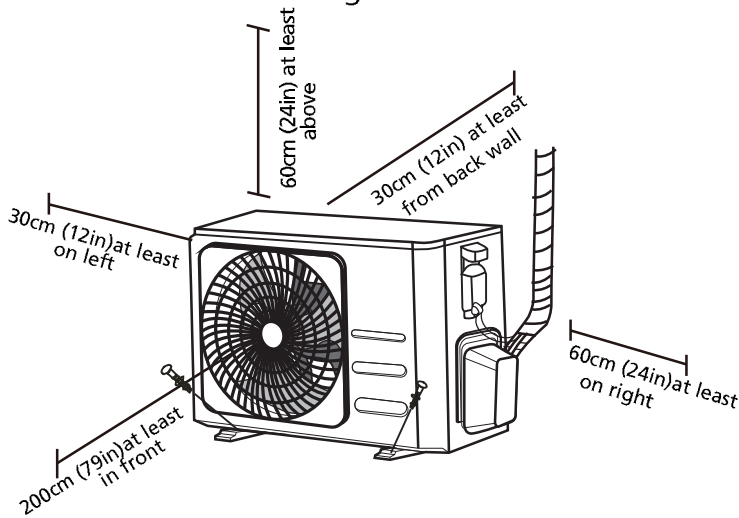

Installation Instructions – Outdoor unit

Step 1: Select installation location

Before installing the outdoor unit, you must choose an appropriate location. The following are standards that will help you choose an appropriate location for the unit.

Proper installation locations meet the following standards:

- Meets all spatial requirements shown in Installation Space Requirements above.
- Good air circulation and ventilation
- Firm and solid—the location can support the unit and will not vibrate
- Noise from the unit will not disturb others
- Protected from prolonged periods of direct sunlight or rain
- Where snowfall is anticipated, take appropriate measures to prevent ice buildup and coil damage.

DO NOT install unit in the following locations:

- ⊘ Near an obstacle that will block air inlets and outlets
- ⊘ Near a public street, crowded areas, or where noise from the unit will disturb others
- ⊘ Near animals or plants that will be harmed by hot air discharge
- ⊘ Near any source of combustible gas
- ⊘ In a location that is exposed to large amounts of dust
- ⊘ In a location exposed to a excessive amounts of salty air

SPECIAL CONSIDERATIONS FOR EXTREME WEATHER

If the unit is exposed to heavy wind:

Install unit so that air outlet fan is at a 90° angle to the direction of the wind. If needed, build a barrier in front of the unit to protect it from extremely heavy winds. See Figures below.

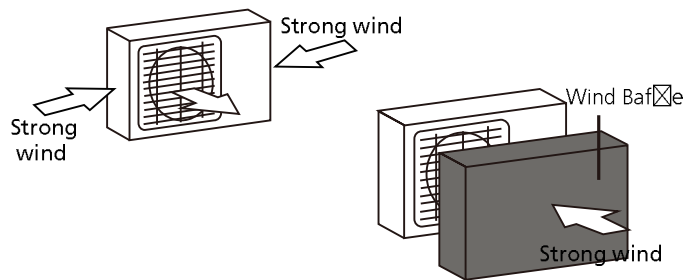

If the unit is frequently exposed to heavy rain or snow:

Build a shelter above the unit to protect it from the rain or snow. Be careful not to obstruct air flow around the unit.

If the unit is frequently exposed to salty air (seaside):

Use outdoor unit that is specially designed to resist corrosion.

Step 2: Install drain joint(Heat pump model only)

Before bolting the outdoor unit in place, you must install the drain joint at the bottom of the unit. Note that there are two different types of drain joints depending on the type of outdoor unit.

If the drain joint comes with a rubber seal (see Fig. A), do the following:

1. Fit the rubber seal on the end of the drain joint that will connect to the outdoor unit.
2. Insert the drain joint into the hole in the base pan of the unit.
3. Rotate the drain joint 90° until it clicks in place facing the front of the unit.
4. Connect a drain hose extension (not supply with unit) to the drain joint to redirect water from the unit during heating mode.

If the drain joint doesn't come with a rubber seal (see Fig. B), do the following:

1. Insert the drain joint into the hole in the base pan of the unit. The drain joint will click in place.
2. Connect a drain hose extension (not supply with unit) to the drain joint to redirect water from the unit during heating mode.

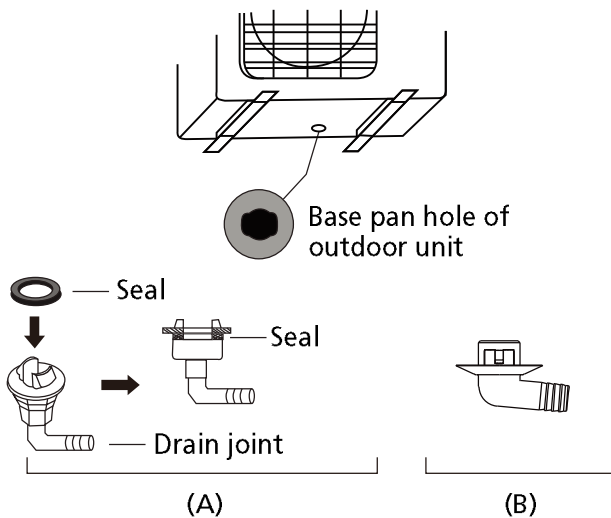

Step 3: Anchor outdoor unit

The outdoor unit can be anchored to the ground or to a wall-mounted bracket with bolt(M10). Prepare the installation base of the unit according to the dimensions below.

UNIT MOUNTING DIMENSIONS

The following is a list of different outdoor unit sizes and the distance between their mounting feet. Prepare the installation base of the unit according to the dimensions below.

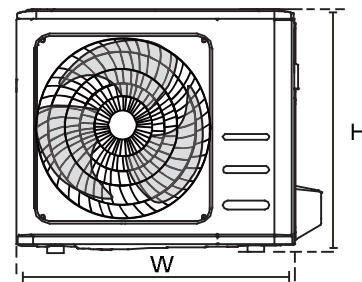
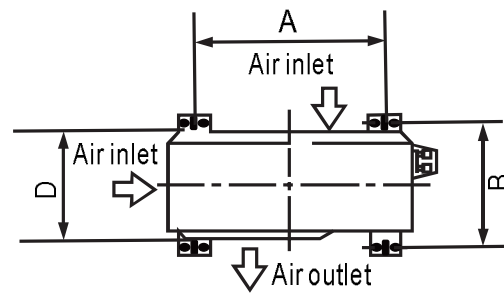

! IN COLD CLIMATES

In cold climates, make sure that the drain hose is as vertical as possible to ensure swift water drainage. If water drains too slowly, it can freeze in the hose and flood the unit.

	Outdoor Unit Dimensions (mm)	Mounting Dimensions	
	W x H x D	Distance A (mm)	Distance B (mm)
RU-S9KI RU-S12KI	720x495x270 (28.3"x19.5"x10.6")	452 (17.8")	255 (10.0")
RU-S18KI	765x555x303 (30.1"x21.8"x11.9")	452 (17.8")	286(11.3")

If you will install the unit on the ground or on a concrete mounting platform, do the following:

1. Mark the positions for four expansion bolts based on dimensions chart.
2. Pre-drill holes for expansion bolts.
3. Place a nut on the end of each expansion bolt.
4. Hammer expansion bolts into the pre-drilled holes.
5. Remove the nuts from expansion bolts, and place outdoor unit on bolts.
6. Put washer on each expansion bolt, then replace the nuts.
7. Using a wrench, tighten each nut until snug.

 **WARNING**

WHEN DRILLING INTO CONCRETE, EYE PROTECTION IS RECOMMENDED AT ALL TIMES.

If you will install the unit on a wall-mounted bracket, do the following:

 **CAUTION**

Make sure that the wall is made of solid brick, concrete, or of similarly strong material. **The wall must be able to support at least four times the weight of the unit.**

1. Mark the position of bracket holes based on dimensions chart.
2. Pre-drill the holes for the expansion bolts.
3. Place a washer and nut on the end of each expansion bolt.
4. Thread expansion bolts through holes in mounting brackets, put mounting brackets in position, and hammer expansion bolts into the wall.
5. Check that the mounting brackets are level.
6. Carefully lift unit and place its mounting feet on brackets.
7. Bolt the unit firmly to the brackets.
8. If allowed, install the unit with rubber gaskets to reduce vibrations and noise.

Step 4: Connect signal and power cables

The outside unit's terminal block is protected by an electrical wiring cover on the side of the unit. A comprehensive wiring diagram is printed on the inside of the wiring cover.

WARNING

BEFORE PERFORMING ANY ELECTRICAL OR WIRING WORK, TURN OFF THE MAIN POWER TO THE SYSTEM.

1. Prepare the cable for connection:

USE THE RIGHT CABLE

Please choose the right cable refer to "Cable types" in page 22.

CHOOSE THE RIGHT CABLE SIZE

The size of the power supply cable, signal cable, fuse, and switch needed is determined by the maximum current of the unit. The maximum current is indicated on the nameplate located on the side panel of the unit.

NOTE: In North America, please choose the right cable size according to the Minimum Circuit Ampacity indicated on the nameplate of the unit.

- Using wire strippers, strip the rubber jacket from both ends of cable to reveal about 40mm (1.57in) of the wires inside.
- Strip the insulation from the ends of the wires.
- Using a wire crimper, crimp u-lugs on the ends of the wires.

PAY ATTENTION TO LIVE WIRE

While crimping wires, make sure you clearly distinguish the Live ("L") Wire from other wires.

WARNING

ALL WIRING WORK MUST BE PERFORMED STRICTLY IN ACCORDANCE WITH THE WIRING DIAGRAM LOCATED INSIDE OF WIRE COVER OF THE OUTDOOR UNIT .

- Unscrew the electrical wiring cover and remove it.
- Unscrew the cable clamp below the terminal block and place it to the side.
- Connect the wire according to the wiring diagram, and firmly screw the u-lug of each wire to its corresponding terminal.
- After checking to make sure every connection is secure, loop the wires around to prevent rain water from flowing into the terminal.
- Using the cable clamp, fasten the cable to the unit. Screw the cable clamp down tightly.

- Insulate unused wires with PVC electrical tape. Arrange them so that they do not touch any electrical or metal parts.
- Replace the wire cover on the side of the unit, and screw it in place.

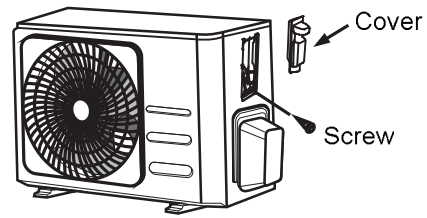

NOTE: If the cable clamp looks like the following, please select the appropriate through-hole according to the diameter of the wire.

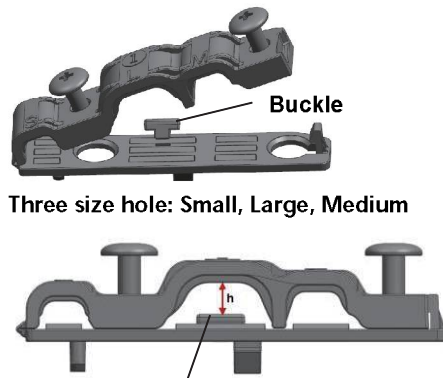

When the cable is not fasten enough, use the buckle to prop it up, so it can be clamped tightly.

Refrigerant Piping Connection

When connecting refrigerant piping, **do not** let substances or gases other than the specified refrigerant enter the unit. The presence of other gases or substances will lower the unit's capacity, and can cause abnormally high pressure in the refrigeration cycle. This can cause explosion and injury.

Note on Pipe Length

The length of refrigerant piping will affect the performance and energy efficiency of the unit. Nominal efficiency is tested on units with a pipe length of 5 meters (16.5ft). A minimum pipe run of 3 metres is required to minimise vibration & excessive noise. In special tropical area, for the R290 refrigerant models, no refrigerant can be added and the maximum length of refrigerant pipe should not exceed 10 meters (32.8ft).

Refer to the table below for specifications on the maximum length and drop height of piping.

Maximum Length and Drop Height of Refrigerant Piping per Unit Model

Model	Capacity (BTU/h)	Max. Length (m)	Max. Drop Height (m)
R410A,R32 Inverter Split Air Conditioner	< 15,000	25 (82ft)	10 (33ft)
	≥ 15,000 and < 24,000	30 (98.5ft)	20 (66ft)
	≥ 24,000 and < 36,000	50 (164ft)	25 (82ft)

Connection Instructions – Refrigerant Piping

Step 1: Cut pipes

When preparing refrigerant pipes, take extra care to cut and flare them properly. This will ensure efficient operation and minimize the need for future maintenance.

1. Measure the distance between the indoor and outdoor units.
2. Using a pipe cutter, cut the pipe a little longer than the measured distance.
3. Make sure that the pipe is cut at a perfect 90° angle.

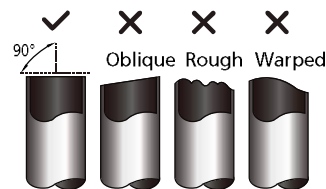

DO NOT DEFORM PIPE WHILE CUTTING

Be extra careful not to damage, dent, or deform the pipe while cutting. This will drastically reduce the heating efficiency of the unit.

Step 2: Remove burrs

Burrs can affect the air-tight seal of refrigerant piping connection. They must be completely removed.

1. Hold the pipe at a downward angle to prevent burrs from falling into the pipe.
2. Using a reamer or deburring tool, remove all burrs from the cut section of the pipe.

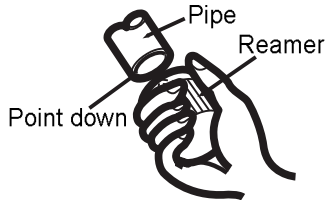

Step 3: Flare pipe ends

Proper flaring is essential to achieve an airtight seal.

1. After removing burrs from cut pipe, seal the ends with PVC tape to prevent foreign materials from entering the pipe.
2. Sheath the pipe with insulating material.
3. Place flare nuts on both ends of pipe. Make sure they are facing in the right direction, because you can not put them on or change their direction after flaring.

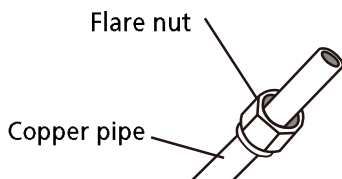

4. Remove PVC tape from ends of pipe when ready to perform flaring work.
5. Clamp flare form on the end of the pipe. The end of the pipe must extend beyond the edge of the flare form in accordance with the dimensions shown in the table below.

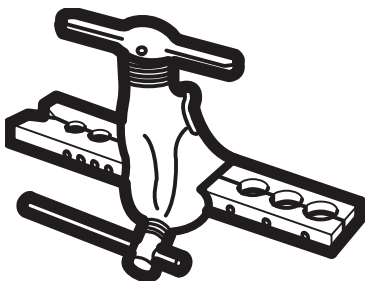

PIPING EXTENSION BEYOND FLARE FORM

Outer Diameter of Pipe (mm)	A (mm)	
	Min.	Max.
Ø 6.35 (Ø 0.25")	0.7 (0.0275")	1.3 (0.05")
Ø 9.52 (Ø 0.375")	1.0 (0.04")	1.6 (0.063")
Ø 12.7 (Ø 0.5")	1.0 (0.04")	1.8 (0.07")
Ø 16 (Ø 0.63")	2.0 (0.078")	2.2 (0.086")
Ø 19 (Ø 0.75")	2.0 (0.078")	2.4 (0.094")

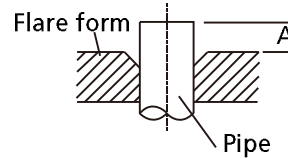

6. Place flaring tool onto the form.
7. Turn the handle of the flaring tool clockwise until the pipe is fully flared.
8. Remove the flaring tool and flare form, then inspect the end of the pipe for cracks and even flaring.

Step 4: Connect pipes

When connecting refrigerant pipes, be careful not to use excessive torque or to deform the piping in any way. You should first connect the low-pressure pipe, then the high-pressure pipe.

MINIMUM BEND RADIUS

When bending connective refrigerant piping, the minimum bending radius is 10cm.

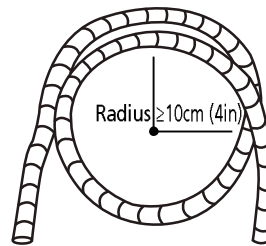

Instructions for Connecting Piping to Indoor Unit

1. Align the center of the two pipes that you will connect.

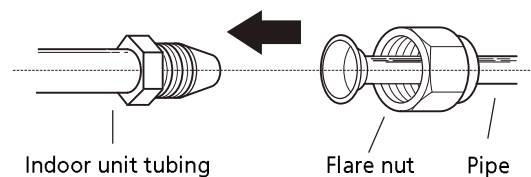

2. Tighten the flare nut as tightly as possible by hand.
3. Using a spanner, grip the nut on the unit tubing.
4. While firmly gripping the nut on the unit tubing, use a torque wrench to tighten the flare nut according to the torque values in the **Torque Requirements** table below. Loosen the flaring nut slightly, then tighten again.

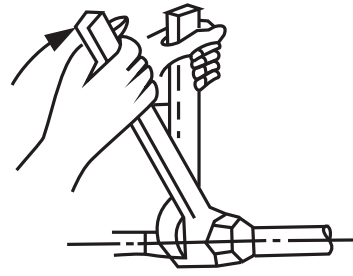

TORQUE REQUIREMENTS

Outer Diameter of Pipe (mm)	Tightening Torque (N•cm)	Flare dimension(B) (mm)	Flare shape
Ø 6.35 (Ø 0.25")	18~20(180~200kgf.cm)	8.4~8.7 (0.33~0.34")	
Ø 9.52 (Ø 0.375")	32~39(320~390kgf.cm)	13.2~13.5 (0.52~0.53")	
Ø 12.7 (Ø 0.5")	49~59(490~590kgf.cm)	16.2~16.5 (0.64~0.65")	
Ø 16 (Ø 0.63")	57~71(570~710kgf.cm)	19.2~19.7 (0.76~0.78")	
Ø 19 (Ø 0.75")	67~101(670~1010kgf.cm)	23.2~23.7 (0.91~0.93")	

⊘ DO NOT USE EXCESSIVE TORQUE

Excessive force can break the nut or damage the refrigerant piping. You must not exceed torque requirements shown in the table above.

Instructions for Connecting Piping to Outdoor Unit

1. Unscrew the cover from the packed valve on the side of the outdoor unit.
2. Remove protective caps from ends of valves.
3. Align flared pipe end with each valve, and tighten the flare nut as tightly as possible by hand.
4. Using a spanner, grip the body of the valve. Do not grip the nut that seals the service valve.
5. While firmly gripping the body of the valve, use a torque wrench to tighten the flare nut according to the correct torque values.
6. Loosen the flaring nut slightly, then tighten again.
7. Repeat Steps 3 to 6 for the remaining pipe.

! USE SPANNER TO GRIP MAIN BODY OF VALVE

Torque from tightening the flare nut can snap off other parts of valve.

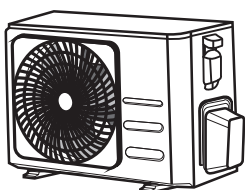

Valve cover

5. While firmly gripping the body of the valve, use a torque wrench to tighten the flare nut according to the correct torque values.

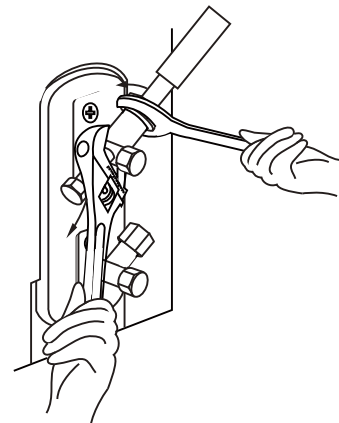

Air Evacuation

Preparations and Precautions

Air and foreign matter in the refrigerant circuit can cause abnormal rises in pressure, which can damage the air conditioner, reduce its efficiency, and cause injury. Use a vacuum pump and manifold gauge to evacuate the refrigerant circuit, removing any non-condensable gas and moisture from the system.

Evacuation should be performed upon initial installation and when unit is relocated.

BEFORE PERFORMING EVACUATION

- ☑ Check to make sure the connective pipes between the indoor and outdoor units are connected properly.
- ☑ Check to make sure all wiring is connected properly.

Evacuation Instructions

Please read the operating manuals before using manifold gauges and vacuum pumps to use them properly.

1. Connect the charge hose of the manifold gauge to service port on the outdoor unit's low pressure valve.
2. Connect another charge hose from the manifold gauge to the vacuum pump.
3. Open the Low Pressure side of the manifold gauge. Keep the High Pressure side closed.
4. Turn on the vacuum pump to evacuate the system.
5. Run the vacuum for at least 15 minutes, or until the Compound Meter reads -76cmHg (-105 Pa).

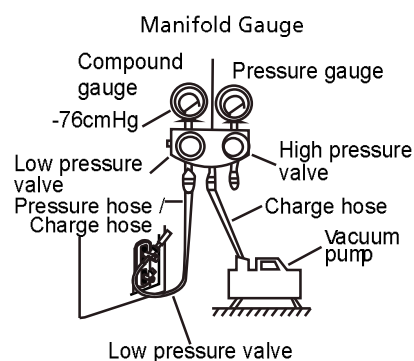

6. Close the Low Pressure side of the manifold gauge, and turn off the vacuum pump.
7. Wait for 5 minutes, then check that there has been no change in system pressure.

8. If there is a change in system pressure, refer to Gas Leak Check section for information on how to check for leaks. If there is no change in system pressure, unscrew the cap from the packed valve (high pressure valve).
9. Insert hexagonal wrench into the packed valve (high pressure valve) and open the valve by turning the wrench in a 1/4 counterclockwise turn. Listen for gas to exit the system, then close the valve after 5 seconds.
10. Watch the Pressure Gauge for one minute to make sure that there is no change in pressure. The Pressure Gauge should read slightly higher than atmospheric pressure.
11. Remove the charge hose from the service port.

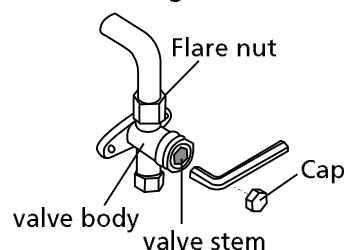

12. Using hexagonal wrench, fully open both the high pressure and low pressure valves.
13. Tighten valve caps on all three valves (service port, high pressure, low pressure) by hand. You may tighten it further using a torque wrench if needed.

! OPEN VALVE STEMS GENTLY

When opening valve stems, turn the hexagonal wrench until it hits against the stopper. Do not try to force the valve to open further.

Note on Adding Refrigerant

Some systems require additional charging depending on pipe lengths. The standard pipe length varies according to local regulations. The refrigerant should be charged from the service port on the outdoor unit's low pressure valve. The additional refrigerant to be charged can be calculated using the following formula:

ADDITIONAL REFRIGERANT PER PIPE LENGTH

Connective Pipe Length (m)	Air Purging Method	Additional Refrigerant	
≤ Standard pipe length	Vacuum Pump	N/A	
> Standard pipe length	Vacuum Pump	Liquid Side: Ø 6.35 (ø 0.25") R410A: (Pipe length – standard length) x 15g/m (Pipe length – standard length) x 0.16oz/ft	Liquid Side: Ø 9.52 (ø 0.375") R410A: (Pipe length – standard length) x 30g/m (Pipe length – standard length) x 0.32oz/ft

 **CAUTION** DO NOT mix refrigerant types.

Electrical and Gas Leak Checks

Before Test Run

Only perform test run after you have completed the following steps:

- **Electrical Safety Checks** – Confirm that the unit's electrical system is safe and operating properly
- **Gas Leak Checks** – Check all flare nut connections and confirm that the system is not leaking
- Confirm that gas and liquid (high and low pressure) valves are fully open

Electrical Safety Checks

After installation, confirm that all electrical wiring is installed in accordance with local and national regulations, and according to the Installation Manual.

BEFORE TEST RUN

Check Grounding Work

Measure grounding resistance by visual detection and with grounding resistance tester. Grounding resistance must be less than 0.1Ω .

DURING TEST RUN

Check for Electrical Leakage

During the **Test Run**, use an electroprobe and multimeter to perform a comprehensive electrical leakage test.

If electrical leakage is detected, turn off the unit immediately and call a licensed electrician to find and resolve the cause of the leakage.



WARNING – RISK OF ELECTRIC SHOCK

ALL WIRING MUST COMPLY WITH LOCAL AND NATIONAL ELECTRICAL CODES, AND MUST BE INSTALLED BY A LICENSED ELECTRICIAN.

Gas Leak Checks

There are two different methods to check for gas leaks.

Soap and Water Method

Using a soft brush, apply soapy water or liquid detergent to all pipe connection points on the indoor unit and outdoor unit. The presence of bubbles indicates a leak.

Leak Detector Method

If using leak detector, refer to the device's operation manual for proper usage instructions.

AFTER PERFORMING GAS LEAK CHECKS

After confirming that the all pipe connection points **DO NOT** leak, replace the valve cover on the outside unit.

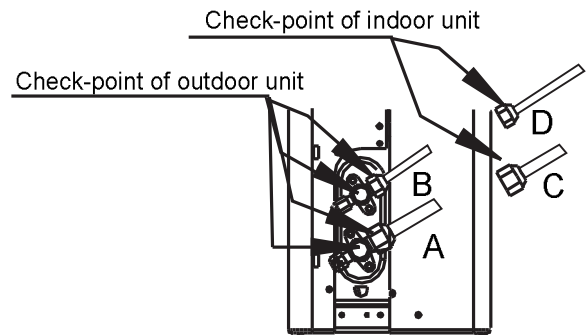

A: Low pressure stop valve
B: High pressure stop valve
C & D: Indoor unit flare nuts

Test Run

Test Run Instructions

You should perform the **Test Run** for at least 30 minutes.

1. Connect power to the unit.
2. Press the **ON/OFF** button on the remote controller to turn it on.
3. Press the **MODE** button to scroll through the following functions, one at a time:
 - COOL – Select lowest possible temperature
 - HEAT – Select highest possible temperature (not applicable)
4. Let each function run for 5 minutes, and perform the following checks:

List of Checks to Perform	PASS/FAIL	
No electrical leakage		
Unit is properly grounded		
All electrical terminals properly covered		
Indoor and outdoor units are solidly installed		
All pipe connection points do not leak	Outdoor (2):	Indoor (2):
Water drains properly from drain hose		
All piping is properly insulated		
Unit performs COOL function properly		
Unit performs HEAT function properly		
Indoor unit louvers rotate properly		
Indoor unit responds to remote controller		

DOUBLE-CHECK PIPE CONNECTIONS

During operation, the pressure of the refrigerant circuit will increase. This may reveal leaks that were not present during your initial leak check. Take time during the Test Run to double-check that all refrigerant pipe connection points do not have leaks. Refer to **Gas Leak Check** section for instructions.

5. After the Test Run is successfully completed, and you confirm that all checks points in List of Checks to Perform have PASSED, do the following:
 - a. Using remote control, return unit to normal operating temperature.
 - b. Using insulation tape, wrap the indoor refrigerant pipe connections that you left uncovered during the indoor unit installation process.

IF AMBIENT TEMPERATURE IS BELOW 16°C (60°F)

You can't use the remote controller to turn on the COOL function when the ambient temperature is below 16°C. In this instance, you can use the **MANUAL CONTROL** button to test the COOL function.

1. Lift the front panel of the indoor unit, and raise it until it clicks in place.
2. The **MANUAL CONTROL** button is located on the right-hand side of the unit. Press it 2 times to select the COOL function.
3. Perform Test Run as normal.

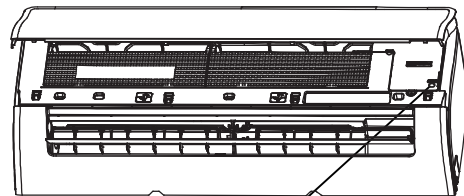

Manual control button

● Special Avowal

- 1. The information above has been checked; our company reserves the hermeneutic power to any print errors or misunderstanding on the content.**
- 2. Any technology improvement will add into new instruction without any prior notices. The product appearance and color refer to the practical air conditioner.**
- 3. The e-copy of user manual can be sent by e-mail on requested, please call Shun Hing Electric Works & Engineering Co. Ltd. hotline at 2861 2767.**

● After sale service

Guarantee period state from the date of purchasing to one year. If the product is damaged under proper use, a free repair service is available. Please present the official invoice and the guarantee certificate with the sales point's chop / redemption center's chop for free maintenance. For enquiries, please contact Shun Hing Electric Service Centre Limited hotline at 2406 5666.

Turn off the power and contact Shun Hing Electric Service Centre Ltd. as soon as any of the following events occur.

- The circuit breaker frequently trips or the fuse blows regularly.
- If water or foreign objects have accidentally entered the air conditioner.
- If there is abnormal sound during operation.



信興電工工程有限公司

SHUN HING ELECTRIC WORKS & ENGINEERING CO., LTD

辦公室: 香港九龍尖沙咀東部麼地道 67 號半島中心 9 樓

OFFICE: 9/F, PENINSULA CENTRE, 67 MODY ROAD, TSIMSHATSUI EAST,
KOWLOON, HONG KONG

電話 TEL: (852) 2861 2767

傳真 FAX: (852) 2865 6706

網址 WEBSITE: www.rasonic.com

電郵 EMAIL: shew@shunhinggroup.com

保養及維修 MAINTENANCE AND REPAIR SERVICE

信興電器服務中心有限公司

SHUN HING ELECTRIC SERVICE CENTRE LTD.

辦公室: 香港新界葵涌勝耀街2號信興中心11樓

OFFICE: 11TH FLOOR, SHUN HING CENTRE, 2 SHING YIU STREET, KWAI CHUNG, NEW
TERRITORIES, HONG KONG

電話 TEL: (852) 2406 5666

傳真 FAX: (852) 2408 0316

網址 WEBSITE: www.shesc.com

消耗品/附件銷售熱線 CONSUMABLES/ ACCESSORIES SALES HOTLINE

電話 TEL: (852) 2406 5666

客戶服務中心 CUSTOMER SERVICE CENTRES

香港新界葵涌勝耀街2號信興中心1樓

1ST FLOOR, SHUN HING CENTRE, 2 SHING YIU STREET, KWAI CHUNG, NEW
TERRITORIES, HONG KONG

電話 TEL: (852) 2406 5439

傳真 FAX: (852) 2408 1389

澳門慕拉士大馬路193-199號南嶺工業大廈5樓I座

AVENIDA DE VENCESLAU DE MORAIS, NO. 193-199, 5 ANDAR-I, EDF. INDUSTRIAL
NAM LENG, MACAU

電話 TEL: (853) 2836 2928

傳真 FAX: (853) 2833 6405

有關最新之客戶服務中心資訊, 請參閱信興服務中心網址: www.shesc.com或致電維修服務熱線查詢。

For the latest information of customer service centres, please visit www.shesc.com or call us at our hotline.